

FACTORY-BUILT FIREPLACE MODEL

• OPUS

Tested and certified by Intertek

- UL 127-1999
- ULC-S610-M87 R-94



OWNER'S MANUAL - INSTALLATION - OPERATION

Keep these instructions for future use.

Manufactured by:

SUPREME

3594 Jarry East, Montreal, QUEBEC, H1Z 2G4

Phone: 1-877-593-4722 Fax: (514) 593-4424

www.supremem.com

info@supremem.com

SUPREME LIMITED LIFETIME WARRANTY

SUPREME FIREPLACES INC. warrants its factory-built fireplaces will be free from defects in material and workmanship, under normal use and service, for a period of twenty-five (25) years from the date of purchase.

This warranty is only intended for the original retail purchaser, given that the product was purchased from SUPREME FIREPLACES INC. or one of its distributors. This warranty is conditional upon correct installation and intended use of our products and does not cover damages caused by misuse of the products. This warranty shall be void if the fireplace is not installed by an authorized qualified technician in accordance with the installation instructions in the manual provided with this product. The installation must meet local and national building codes.

WARRANTY LIMITATIONS:

If the fireplace is used according to the instructions in the manual, a slight deformation of the panels can occur. This does not affect the functionality or the safety of the fireplace and the replacement of the panels is not necessary. If the fireplace is abused and not used according to our instructions, excessive deformation can occur. In this case, the stainless steel panels must be replaced at the cost of the customer.

1. During the first two years of the Limited Warranty, SUPREME FIREPLACES INC. will provide replacement parts at no charge and will also pay for reasonable labor costs for repair work, except for the parts listed in the EXCLUSIONS portion of this warranty.
2. During the third through the fifth year of the limited warranty, SUPREME FIREPLACES INC. will provide replacement parts (if available) at no charge, except for the parts mentioned in the EXCLUSIONS portion of this warranty. Supreme Fireplaces Inc. shall not be responsible for any labor costs.
3. From the sixth through the twenty-fifth year of the limited lifetime warranty, SUPREME FIREPLACES INC. will provide replacement parts (if available) at 50 % of the retail price, except for the parts listed in the EXCLUSIONS portion of this warranty. SUPREME FIREPLACES INC. shall not be responsible for any labor costs.

Transportation and other related costs or expenses arising from the replacement or repair of defective parts will not be covered by this warranty, nor will SUPREME FIREPLACES INC. assume responsibility for them.

EXCLUSIONS

SUPREME FIREPLACES INC. shall not be responsible for any labor costs for the replacement or repair of any electrical components, painted or plated parts, secondary air burning system, stainless steel panels and automatic air control.

The following parts are guaranteed for 1 year: blowers, painted/plated parts, secondary air burning system, door gasketing and stainless steel panels.

The following parts are guaranteed for 90 days: ceramic glass (Thermal Breakage ONLY).

This warranty applies to normal residential use only. Damages caused by misuse, abuse, improper installation, over-firing, abrasives, chemical cleaners, negligence are not covered by this warranty.

SUPREME FIREPLACES INC will not be responsible for environmental conditions such as inadequate vents or ventilation, excessive venting configurations or negative air pressures which may or may not be caused by mechanical systems such as exhaust fans, furnaces, clothes dryers, etc.

The manufacturer at its discretion may decide to repair or replace any part or unit after inspection and investigation of the defect. The manufacturer may, at its discretion, fully discharge all obligations with respect to this warranty by refunding the wholesale price of the defective part(s).

The manufacturer shall in no event be responsible for any consequential damages of any nature, which are in excess of the original purchase price of the product. Any complete fireplace, or part thereof, that is replaced or serviced under this warranty will be warranted for a period not exceeding the remaining term of the original warranty.

This limited Lifetime Warranty is effective on all appliances sold after January 1st, 2008 and supersedes any and all warranties currently in existence.

INSTALLATION INSTRUCTIONS

Note: Authority having jurisdiction (such as the municipal building department, the fire department, the fire prevention bureau, etc) must be consulted before installation to determine if a building permit is required.

CAUTION: Read these instructions carefully before starting the installation. Failure to follow these instructions may result in property damage, bodily harm and even death.

Note: Do not install a fireplace insert inside the factory-built fireplace, unless the insert has been tested and is SPECIFICALLY CERTIFIED for use in conjunction with this model.

WARNING: As this fireplace is only intended for burning wood, do not install an unvented gas log set into the structure.

LOCATION OF THE FIREPLACE

Select the appropriate location for the fireplace. The position of the fireplace should be selected on the basis of heat output, safety and esthetics.

The cutting of joists and rafters for floor, ceiling and roof chimney penetrations will affect the load bearing capacities of the dwelling structure. Improper cutting of chimney openings in the attic and roof will affect the bearing and thermal insulating capacity as well as the weather tightness of the dwelling. Incorrect workmanship must be avoided.

Consult a professional engineer or a certified installer if needed.

If possible, select a location for the fireplace that will minimize the number of offsets in the chimney course. Offsets will reduce the draft, complicate the chimney sweeper's work and increase installation costs.

An installation drawing should be prepared prior to the installation work.

FIREPLACE INSTALLATION

The fireplace can be placed directly onto or against normal, combustible construction materials such as lumber, plywood, millboard, particleboard, drywall and decorative wood paneling.

The fireplace should NOT be placed directly against, or be in contact with an insulation material.

The framing around both faces of the fireplace should be constructed with nominal 2" x 4" construction lumber or metal studs. The framing must be nailed or screwed onto a podium and to the ceiling. As there are some differences between the podium requirements in Canada and in the US, it is very important to consider in which country the installation will be made. The Figure 1 shows the minimum framing dimensions for US and Canada.

DO NOT NAIL OR SCREW FRAMING MEMBERS INTO THE FIREPLACE.

Position the fireplace at the selected location, taking care of respecting the minimum clearances to combustible materials shown in Figure 2.

The minimum dimensions of the hearth extension are specified in Figure 2. The hearth extension is to be covered with non-combustible materials only, such as steel, cement or mortar, stone, brick, ceramic tiles. The ceramic tiles must have a minimum thickness of 5/16" or an equivalent thickness of the other materials. Unidentified materials may be combustible: verify the product specifications prior to installation.

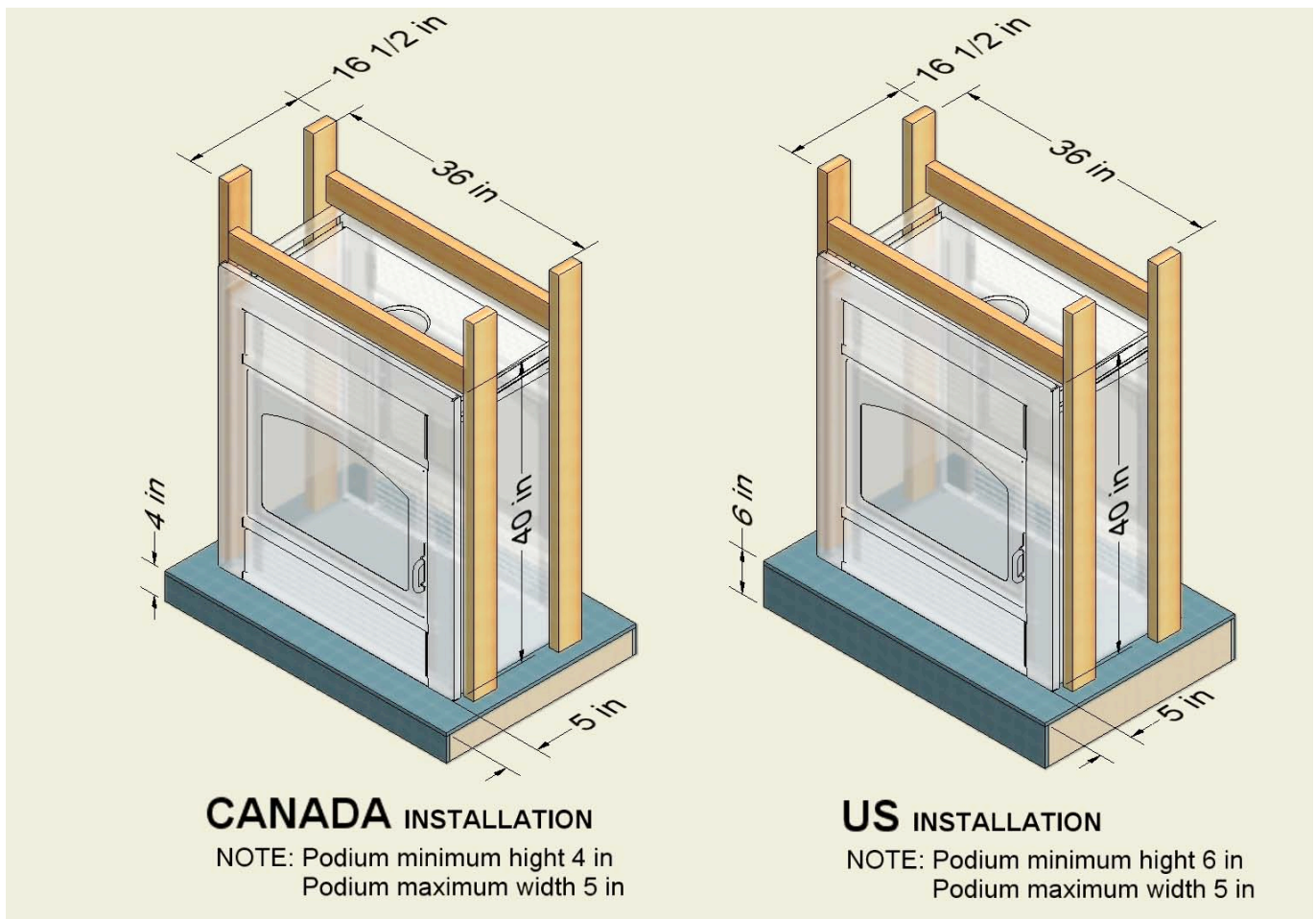

Figure 1

Make sure to seal the gap between each fireplace face and the hearth extension with a metal strip or a sand-cement grout in order to prevent sparks or embers from reaching combustible materials.

CLEARANCES TO COMBUSTIBLES

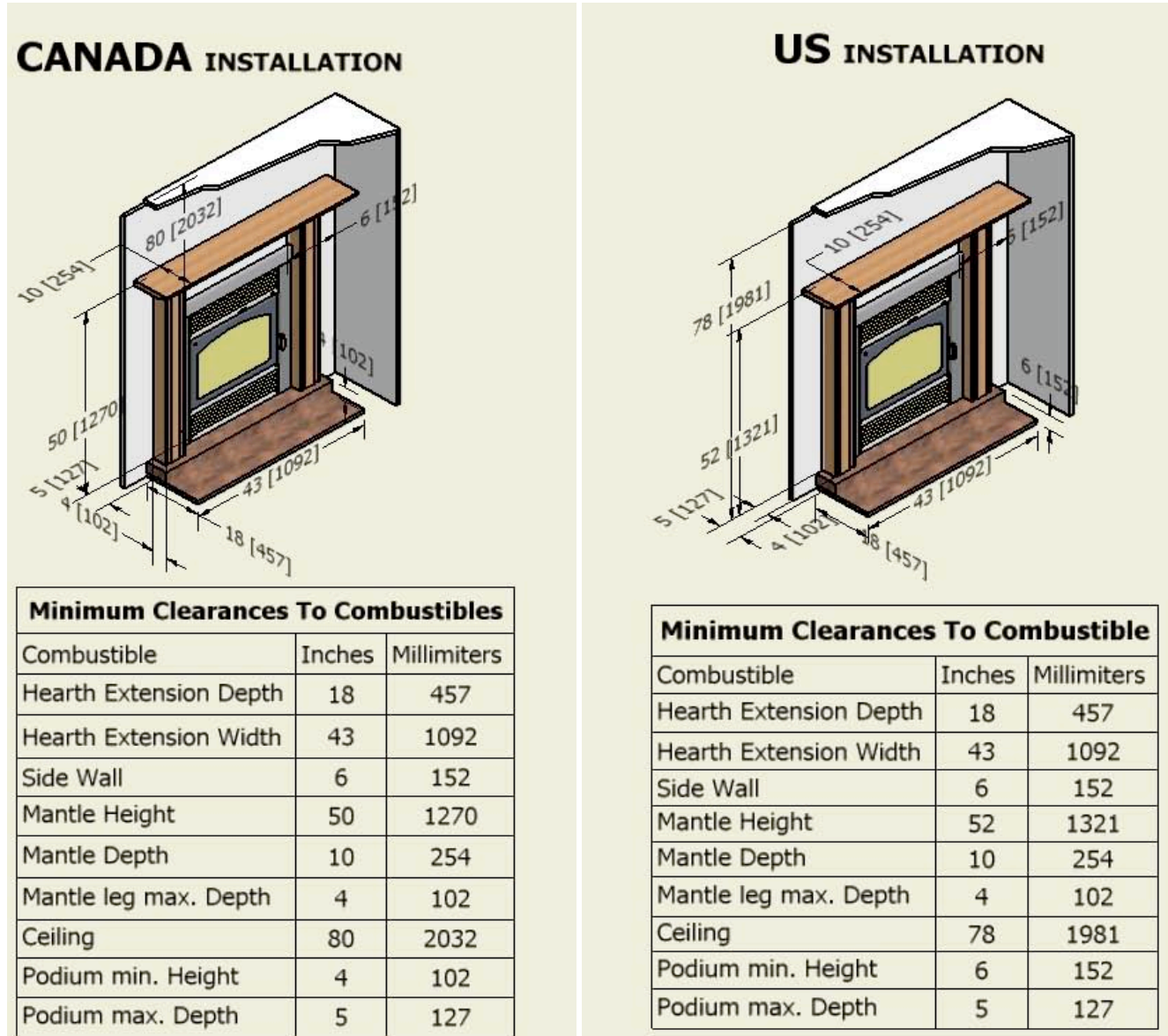

Figure 2

WARNING: The hearth extension has to be installed only as illustrated.

CLEARANCE TO THE FRONT OF THE FIREPLACE

The minimum distance between the front of the fireplace and any combustible material is 5 feet, (152 cm). Do not place such materials within this minimum distance in order to reduce risk of fire.

CHIMNEY INSTALLATION

The fireplace has been tested in accordance to ULC S610-M87 R-94 and UL 127-1999 standards for factory-built fireplaces and can be installed with any of the 6 in. chimneys listed in the below table. The OPUS was also tested in accordance with the U.S. EPA 40 CFR Part 60, Subpart AAA-Standard of Performance for Residential Wood Heaters.

Table 1 – Chimneys	
Manufacturer	Models
ICC	Excel 2100-2
Security Chimneys Intl	Secure Temp ASHT, Secure Temp S-2100, Oliver MacLeod HT6000
Selkirk	SuperPro SPR, SuperPro 2100 ALT, SuperVent JSC, SuperVent 2100 JM, Ultra Temp, CF Sentinel
Simpson Dura-Vent	Duratech HT, Duraplus HTC
Metal Fab	Temp Gard class A
American Metal	Ameritech HS, HSS

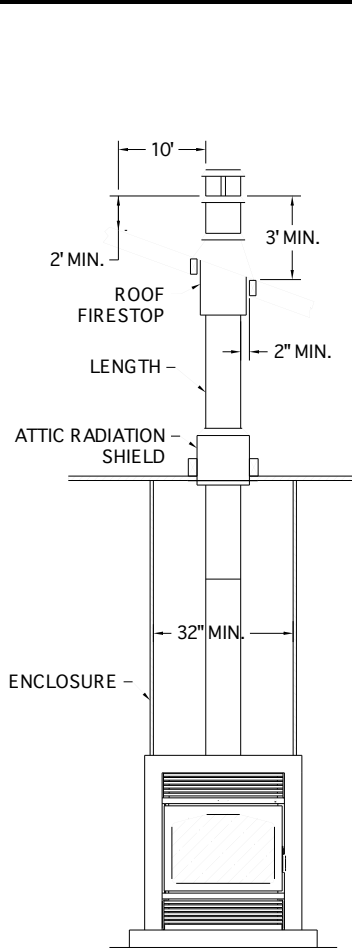

Figure 3

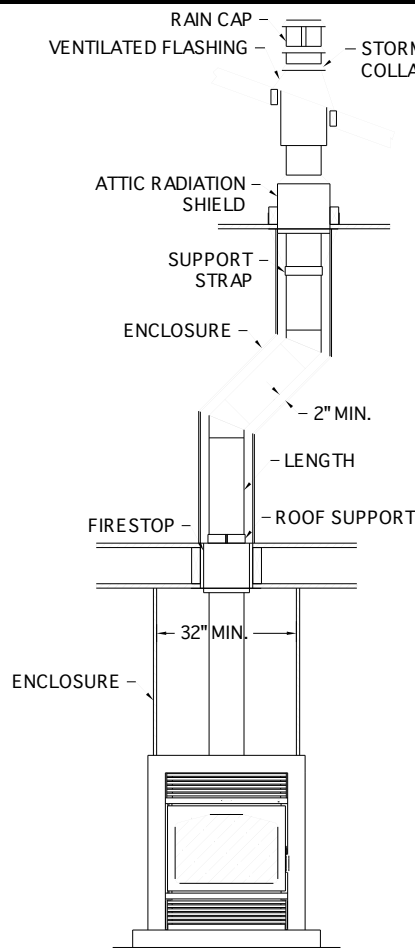

Figure 4

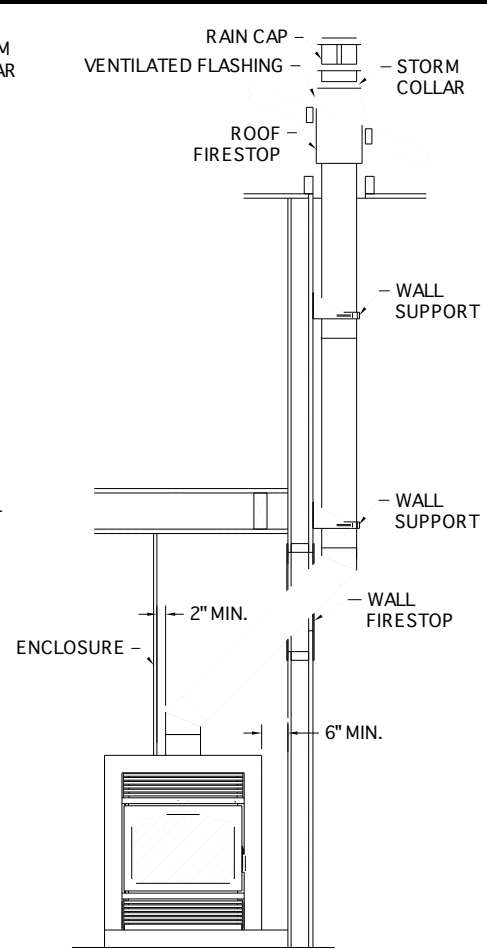

Figure 5

CAUTION: Follow the chimney manufacturer’s instructions for correct chimney installation, unless otherwise specified in these instructions.

General rules

- The height of the chimney, including the fireplace, must be between 15 and 35 feet.
- The chimney must be connected only to the fireplace to be installed: it must not be connected to any other appliance.
- Portions of the chimney that extend through accessible spaces shall be enclosed by an enclosure.
- The clearance between the chimney and any combustible material must not be less than 2 in.: this free space must not be filled with insulation or any other material.
- A fire stop is required at each joist where the chimney goes through a ceiling or floor and through a wall.
- The chimney shall extend at least 3 ft above its point of contact with the roof and at least 2 ft higher than any wall, roof or adjacent building within a radius of 10 ft.
- If the chimney extends 5 feet or more above the roof, roofers are required.
- A rain cap must be installed on the top of the chimney in order to avoid internal damage and corrosion.

Obtain the chimney installation instructions from your vendor, prior to installation of the chimney. The chimney installation must comply with the chimney manufacturer's instructions, unless otherwise noted in these instructions.

An anchor plate, supplied by the chimney manufacturer, must be fixed on the fireplace top with four self-tapping screws. The connection of the chimney to the fireplace is done by installing the first chimney section (or an elbow) to the anchor plate. The figures 3, 4 and 5 show typical installations: your installation may be different from these figures.

Offset Installation

In order to avoid obstacles or to extend the chimney outside, it is possible to offset the aforementioned by using elbows (Figures 4 and 5).

- A maximum of two offsets (2 elbows by offset) is permitted.
- The allowable maximum deviation is 45° in Canada and 30° in the US.
- Secure the chimney parts according to the instructions given by the chimney manufacturer.
- A support strap, a wall or a roof support must be installed above each offset in order to support the vertical length of the chimney above the offset.
- The chimney must extend vertically through a ceiling/floor: do not install elbows in this area.

Roof Flashing Installation

The flashing must be selected in order to fit with the roof slope. Always install a ventilated flashing.

- Make a square opening in the roof with a minimum clearance of 2" between the chimney and each side of the opening.
- Install a roof fire stop if this part is required by the chimney manufacturer.
- Position the flashing. For sloping roofs, slide the top edge of the flashing under the shingles. At least half of the flashing should be under the shingles and the lower end over the shingles. Seal the joint between the roof and the flashing with roofing cement or silicone. Fix the flashing to the roof with roofing nails.
- Wrap the storm collar around the chimney above the flashing and tighten it with the bolt supplied. Apply silicone on the joint between the chimney and the storm collar.
- Install the rain cap.

N.B.: Always install a ventilated flashing and a roof fire stop, unless it is otherwise specified by the chimney manufacturer.

CONNECTION TO A MASONRY CHIMNEY

The OPUS fireplace can be connected to a masonry chimney. The masonry chimney must comply with the national and local building codes.

A stainless steel liner of 6 in. diameter, complying with the standard ULC-S635-M2000 in Canada or UL-1777 in the US, must be installed in the chimney. The liner must be continuous and its installation must comply with the manufacturer's instructions.

An insulated chimney from the model specified in Table 1 must extend from the fireplace to at least 3 in. inside the masonry chimney and connect to the chimney liner. Use the liner connector designed by SUPREME as shown in Figure 6.

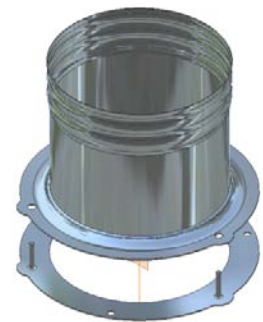

Figure 6

General notes:

Before the installation, the masonry chimney must be inspected by authority having jurisdiction to determine the following:

1. if the chimney is constructed in accordance with local building codes and the national building code;
2. if it has been thoroughly cleaned and inspected to determine that it is in good condition; repair it, if necessary;
3. that the chimney is not shared with other appliances such as a furnace, a hot water heater or another fireplace;
4. that the flue of the chimney is of adequate size for the fireplace to be installed.

Installation

The fireplace must be placed as close as possible to the existing chimney.

The minimum clearances to combustibles as stated in the owner’s manual must be respected.

It is preferable to use elbows to deviate and enter the masonry chimney when possible as shown in Figure 7.

If the deviation is greater than 45° in Canada (30° in the US), then use a tee at the base of the chimney.

The prefabricated chimney and the liner must be installed according to the manufacturer’s instructions.

Here are the steps to follow:

- Install the anchor plate on the top of the fireplace.
- Place the fireplace at the desired location.
- Install elbows, if required.
- Mark where the prefabricated chimney will penetrate the masonry chimney.
- Remove the fireplace so it will be easier to work.
- Make a hole to the required size so the prefabricated chimney can be inserted freely in the masonry chimney.
- Fix with three self-tapping screws the flange holder (aligned with the center of the prefabricated chimney) on the upper end of the elbow (or tee) to be connected to the liner.
- Place and level the fireplace at the desired location.
- Install fire stops if you are penetrating a combustible wall.
- Install the required elbows and chimney lengths to the center of the masonry chimney.
- Insert at least one inch of the lower end of the liner in the slightly expanded end of the liner connector and fix them with three self-tapping screws #8: make sure the connector flange is already inserted around the liner connector.
- Bring the liner down from the top of the masonry chimney and insert the liner connector in the upper end of the prefabricated chimney.
- Align the holes of the connector flange with the threaded studs of the flange holder, and secure the connection with the wing nuts.
- Fill with mortar the opening around the prefabricated chimney.

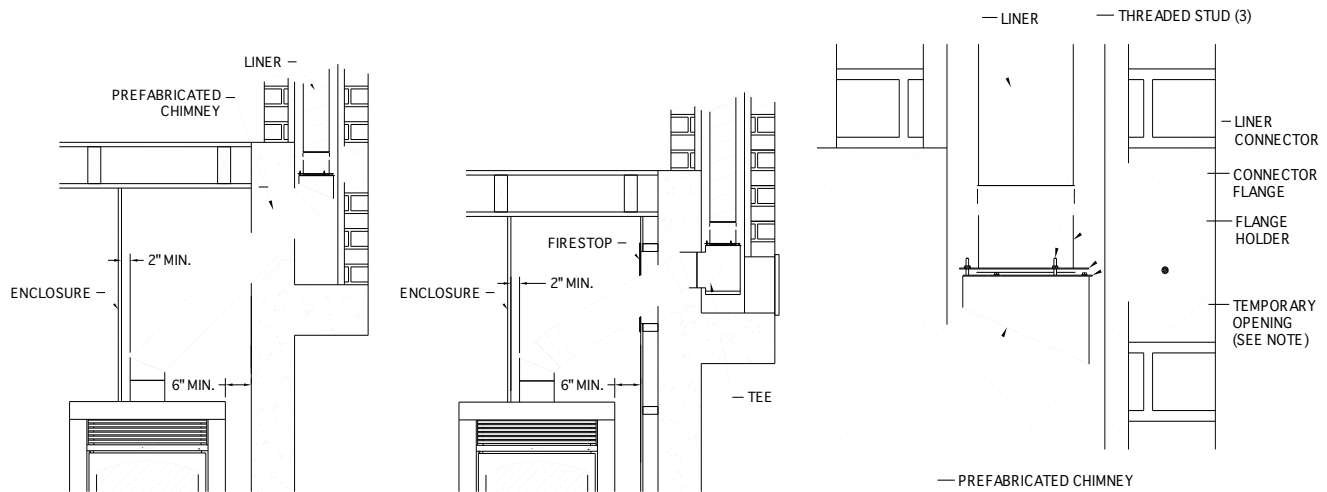

Figure 7

NOTE: It might be necessary to create a small temporary opening in the side of the chimney to facilitate the connection of the liner to the prefabricated chimney. Close this opening after the installation is completed with refractory materials.

WARNING: Always respect the minimum clearances to combustibles. A 2 inch minimum clearance is required for the prefabricated chimney.

HOT DUCT (OPTIONAL)

The air duct system is an optional kit intended to bring warm air to a remote area of the same room or to rooms other than the room where the fireplace is installed. It is possible to install up to two air ducts.

Note that the hot air duct must be insulated and approved for a temperature of at least 210 °F.

WARNINGS:

1. The blower must not be installed in the fireplace casing.
2. When the hot air duct passes through the chase of the fireplace, the minimum distance to combustible materials must be respected. The duct must be secured to prevent accidental displacement.
3. The minimum distance between the blower and the fireplace is 3 feet.
4. Do not use a speed control for the blower.

Installation

To install the hot air system:

1. Knock on a knockout of the fireplace to clear an opening (Figure 8).
2. Install the fireplace duct connector item #5 on the side of the fireplace. Secure with four screws.
3. Choose the room in which the hot air is desired to flow through. Cut an opening of 6 x 7.5 in.
4. Find a suitable location to install the blower (item #2).
5. Install the wall-duct connector (item #7).
6. Install the air duct and secure it with a clamp (item #4).
7. Install the wall grill (item #6).
8. Make the electrical connections (Figure 10). The electric power must be 115 volts.

CAUTION: Only remove the knockouts where the air duct will be installed. Removing a knockout without installing an air duct could compromise the safety of your fireplace.

WARNING: If the grill is installed near a wall, the grill openings must be positioned in such a way to direct hot air away from the wall.



Figure 8

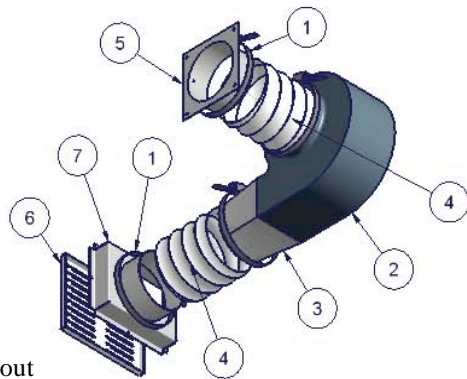

Figure 9

Parts list			
ITEM	QTY	PART #	DESCRIPTION
1	4	CLP	Clamp
2	1	701710	Blower
3	1	BLC	Blower-Duct Connector
4	2	UCAC5	Hot Air Duct
5	1	FCD	Fireplace-Duct Connector
6	1	HAG	Hot Air Grill
7	1	WDC	Wall-Duct Connector

Note: All electrical connections must be made by qualified electricians with well-known components and methods.

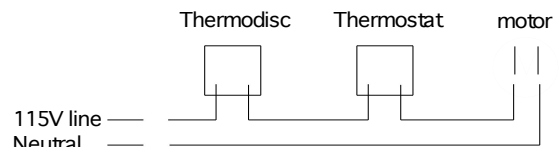

Figure 10

FRESH AIR

Sufficient air exchange is necessary for the fireplace to operate properly. Air is required in order to maintain the combustion of the fireplace. If the house is airtight, the fireplace may not function properly. If the fireplace is deprived of air, it will be necessary to provide a source of fresh air into the dwelling. This may be done by using an air exchanger unit or simply by opening a window slightly.

FRESH AIR (OPTIONAL)

General notes

The outside air kit should be installed according to the following guidelines.

- The air duct must be insulated and have a 4 in. inside diameter.
- The length of the air duct should be as short as possible.
- Fresh air must come from the outside and not from another room or the attic.
- The outside register must be away from automobile exhaust fumes, gas meters or other vents.
- Avoid installing the air register where it will likely be covered by snow or exposed to strong winds.
- The air register could be installed above or below the level where the fireplace is installed.
- Use a SUPREME FRESH AIR KIT or any other fresh air kit intended for fireplace use.

Installation:

- Make a 4 ½ in. hole in the outside wall at the chosen location.
- Install the air register.
- Remove the flange from the side of the fireplace (Figure 11).
- Insert the fresh air adaptor (Figure 12).
- Secure the fresh air adaptor with a flange.
- Install the air duct and secure it with duct clamps.

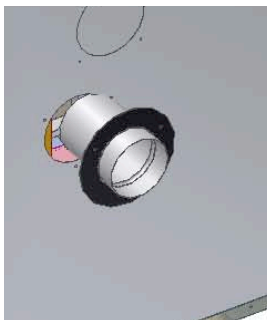

Figure 12

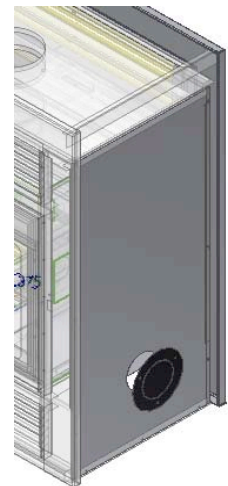
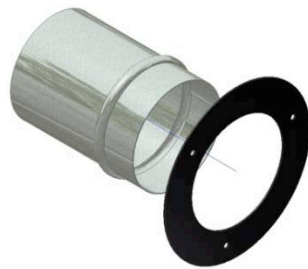

Figure 11

OPERATING INSTRUCTIONS

Important note: Do not keep the door open while the fireplace is lit.

WOOD

The fireplace is designed to burn good quality dry cordwood. The optimum log length is 18 in. and preferably split in halves or quarters. Cordwood should be split and left to dry for one year prior to use.

Use only good quality dry cordwood. DO NOT burn coal, construction lumber, plastics, garbage or other foreign materials in your fireplace.

WARNING: Never use gasoline, gasoline-type lantern fuel, kerosene, charcoal, lighter fluid, or similar fluids to start or re-ignite a fire in the fireplace. Keep all such liquids far away from the fireplace while it is in use.

CREOSOTE FORMATION AND THE NEED FOR REMOVAL

When wood is being burned slowly, it produces tar and other organic vapors that when combined with expelled moisture forms creosote. The creosote vapors condense in the relatively cool chimney flue of a slow burning fire. As a result, creosote residue accumulates on the flue lining. When ignited, this creosote makes an extremely hot fire.

The chimney should be inspected periodically during the heating season to determine if creosote build-up has occurred. If a significant layer of creosote has accumulated (1/8" or more) it must be removed to reduce the risk of chimney fire.

TO SWEEP THE CHIMNEY

- 1) Open the fireplace door.
- 2) Push the chimney sweep cap upwards and place it on the side. The chimney sweep cap is located on top of the tow stainless steel combustion pipes.
 - ◀
- 3) Close the fireplace door.
- 4) Sweep the chimney.
 - ◀
- 5) Open the door of the fireplace and empty out all the residues.
- 6) Place back the chimney sweep cap.

Note: The chimney sweep cap is sealed with silicon for transport. After the first fire, the silicon will burn and you will be able to move the cap.

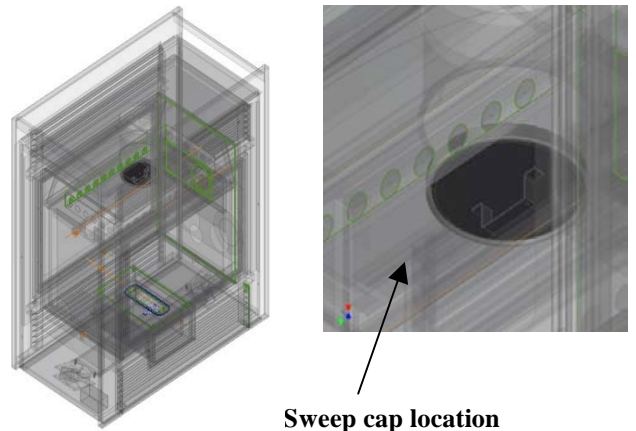

COMBUSTION CONTROL

The burn rate and the heat output are related to the amount of combustion air. The control handle rotates from the right (maximum) to the left (minimum) position (Figure 13). It can also be pushed inwards to allow additional air in for start-up or when a new charge of wood is being loaded.

OPERATION OF THE COMBUSTION AIR CONTROL MECHANISM

When starting the fire or when adding a new charge of wood, the fireplace needs additional air in order to establish a good fire. When the wood starts to burn properly, the amount of air can be reduced depending on the heating requirements.

The control mechanism provides automatic means to gradually reduce the combustion air to the preset amount. The preset amount will be established by the operator, depending on his heating requirements, the type and condition of the wood being used.



Figure 13

The control can rotate from minimum to maximum. It can also be pushed in and out

To determine the preset amount, the user will have to use the fireplace for several days, placing the control handle at different positions between minimum and maximum.

After establishing a position for the control, push the control handle fully inwards and then pull it back when starting a fire in order to maximize the combustion air. The combustion air will gradually reduce to the pre-set position when the wood will start to burn properly.

Note: Once the control handle has been pushed inwards, it is not possible to reduce the combustion air by rotating the control handle. The fireplace must burn at a good rate and for a given period of time in order to allow the control to gradually reduce the amount of combustion air to the preset amount.

WARNING: READ THE OWNER'S MANUAL CAREFULLY. Also read the following brief instructions before using your fireplace.

Note: It is important to assure that a flame is maintained. If the flame is not maintained, reestablish it by cracking the door open again. **Do not leave the fireplace with the door unlocked without supervision.**

Caution: The wood should be placed away from the door to avoid damage to the glass.

WARNINGS: Over firing the unit may result in overheating and can damage the fireplace or/and result in fire hazards. The maximum firewood load must not exceed 4 medium sized logs (approximately 30 pounds). Open the door to reload only when the wood has been reduced to charcoal, otherwise there is a risk of smoke infiltration into the house.

- This fireplace has been designed to burn with the door closed. When the fireplace is being used, the door should only be opened when adding more wood.

STARTING THE FIRE

Assure that all the safe precautions mentioned in the owner's manual are being respected.

1. Place 2 logs at the hearth of the firebox (Figure 15).
2. Place a fire starter on top of the logs.
3. Light the fire starter.
4. Place 1-2 logs on top of the fire starter.
5. Close the door.
6. Activate the control by pushing and retracting it.

Summary of Operation of the Automatic Air Control:

1. Select the burning rate for the season.
2. Push and retract the control handle when starting the fire or when adding wood.

ADDING A NEW CHARGE OF WOOD

When the wood has been reduced to charcoal, add a new load.

1. Bring the wood near the fireplace.
2. Unlock the door for 2-3 minutes to activate the remaining charcoal.
3. Open the door slowly and add 2-3 logs.
4. Push the door closed without locking it. Hold the door closed until you establish a flame.
5. When a solid flame has been established, lock the door and activate the control by pushing and retracting it.

Note: It is important to assure that a flame is maintained. If the flame is not maintained, re-establish it by cracking the door open again. Do not leave the fireplace unsupervised with the door unlocked.



Figure 14 - Not recommended



Figure 15 - Recommended

REMOVAL OF ASHES

Regularly empty out the ashtray. The removal of the ashes should be done when the fireplace is cold.

To empty the ashtray:

1. Push down the ashes through the openings of the floor plate so that they fall into the ashtray. Do not overfill the ashtray.
2. Pull down the lower louver.
3. Open the ashtray door.
4. Remove the ashtray.
5. Empty the ashes into a metal container.
6. Re-place the ashtray and close the ashtray door.
7. Close the lower louver.

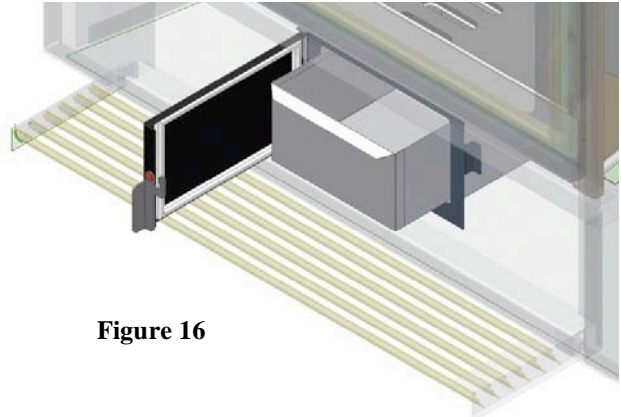

Figure 16

Disposal of Ashes

Ashes should be placed in a metal container with a tight-fitting lid, taken outside and placed on the ground, well away from all combustible materials and pending final disposal. The ashes should be retained in a closed container until they have cooled before disposing of them.

WARNINGS:

- Even if the fireplace has not been in use for two days, the ashes can still contain hot embers.
- Since the ashtray and the container can become very hot, wear gloves to avoid burns.
- Never operate the fireplace with the ashtray door open.
- Inspect regularly the ashtray door gasket and replace it if necessary.
- Never operate the fireplace with the ashtray door gasket worn-out or damaged.

GLASS DOORS

The glass door of your fireplace must be treated with care, do not slam the doors shut or build the fire too close to the glass. Do not overfire. Excessive temperatures or impacts may lead to breakage.

The glass panel is a heat-resistant ceramic type, 5 mm thick.

Replace immediately a cracked or broken glass.

Do not use the fireplace with cracked or broken glass; doing so may result in a fire hazard.

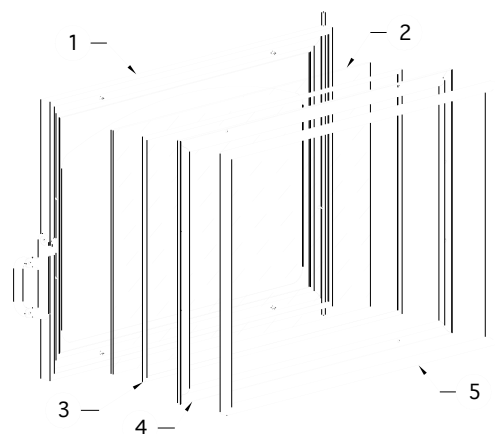

Figure 17

Door assembly:

1. Door frame
2. Glass
3. Glass gasket
4. Glass supports
5. Door gasket

To replace a broken glass:

CAUTION: Always wear gloves and protective glasses to avoid injuries.

1. Order a pre-cut replacement glass, a door gasket and a glass gasket from your dealer (see NOTE).
2. To remove the door, open the door, lift it and pull it towards the bottom until the rod exits from the hinge holes.
3. Remove the gasket.
4. Remove the nuts, the glass supports and the glass gasket.
5. Remove the broken pieces. Clean the frame carefully to insure that it is free of small fragments.
6. Insert the new glass into the door frame: it must be centered in such a way to avoid contact between the glass and the metal supports.
7. Apply a bead (width between 1/8" and 5/32") of high temperature silicone on the glass while following its outline and fix on it the new glass gasket.
8. Fix the glass supports to the door frame. Do not over tighten the nuts.
9. Clean the slot embedding the door gasket and apply on the bottom of the slot a bead (width between 5/32" and 3/16") of high temperature silicone.
10. Install the new door gasket in the slot.

NOTE – Use only ceramic glass of a minimum thickness of 5 mm, dimensions 17" x 24 1/4".

WARNINGS:







- Do not slam the door shut. If your glass door cracks or breaks, replace the panel immediately.
- Do not overfire the fireplace.
- Never operate the fireplace without a gasket or with a damaged one.
- Do not use substitute materials.
- Install only ceramic glass of a minimum thickness of 5 mm.

GLASS CLEANING

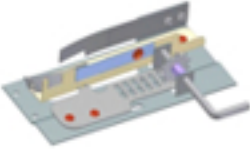
If necessary, the glass door may be cleaned with a soft cloth, using a non-abrasive solution such as soap and water. Commercial glass cleaners such as KEL-KEM will produce better results.

WARNINGS:

- Abrasive cleaners must not be used because they will produce surface scratches, reducing panel transparency and resistance to impacts.
- Do not clean glass when it is hot. The glass panels should be cleaned when the fireplace is not functional.

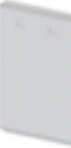
REPLACEMENT PARTS		
CODE	DESCRIPTION	ITEM
PASP2000	Primary air control	
CPSP0170 S2FP1090	Secondary air pipes	
DOSP1051	Glass Ceramic 5mm 17 x 24.25 in	
WP32	Door handle	
DOSP1071	Door Gasket rope 5/8 in x 7 feet	
ASHT1044	Ashtray Gasket rope 1/2 in x 3 feet	
DOSP1061	Glass Gasket rope 3/8 in x 7 feet	
S2FP1071	Firebox Pipe Support Panel	
S2FP1060	Firebox Secondary Air Panel	