

# PRODUCT CATALOGUE

## Direct-Temp<sup>®</sup> for Multi-Fuel **DT-M**

**3" / 5" and 4" / 7" Diameters**



CORN, WHEAT and  
other BIO-FUELS



Get the Selkirk<sup>®</sup> Advantage...

*The tradition continues... Selkirk is the original innovator of prefabricated Venting systems - and we continue to move forward. Count on Selkirk, the world's most recognizable name in Chimney & Venting, for the widest range of high-performance products to meet your needs.*



# Direct-Temp / Multi-Fuel (DT-M) Appliance Venting Solution

Direct-Temp / Multi-Fuel (DT-M) is a unique venting system designed to address the problem of highly corrosive flue gases produced by burning corn or other bio-fuels.

- Converts any conventional corn-burning or multi-fuel stove into a Direct Vent system.
- DT-M 3 x 5 and 4 x 7 systems easily connect to 3" or 4" flue outlets.
- Strong positive seal that's able to handle both positive and negative pressure direct venting applications.
- Laser-welded, double-wall system made from the toughest alloys.
- Concentric design eliminates the need for two separate penetrations.

## Bio-Fuel Alternatives

- |                |                        |                       |
|----------------|------------------------|-----------------------|
| • Corn         | • Olive pits           | • Processed silage    |
| • Hulled wheat | • Cherry pits          | • Grass Pellets       |
| • Soy beans    | • Bio-mass fuel grains | • Waste paper pellets |

## Direct-Temp / Multi-Fuel (DT-M) Specifications

- Inner liner constructed of AL 29-4C Stainless Steel with built-in seal
- Outer jacket constructed of 409 Stainless Steel
- 1" clearance to combustibles
- Available in 3" and 4" diameters
- "Smart Choice" Lifetime Warranty

## Typical Installations

### Through-The-Roof Installation

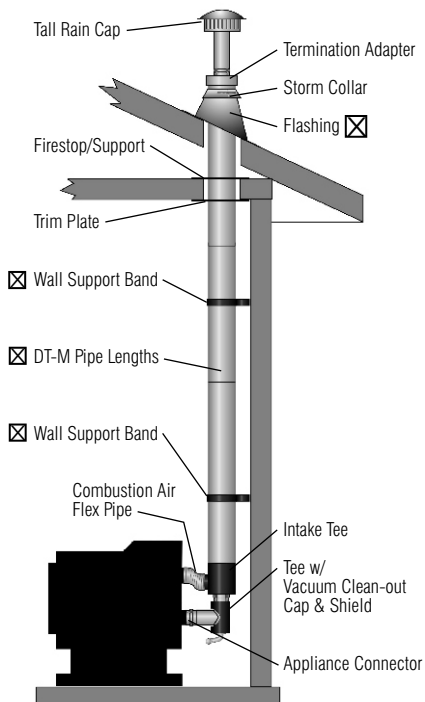

### Up & Out Installation

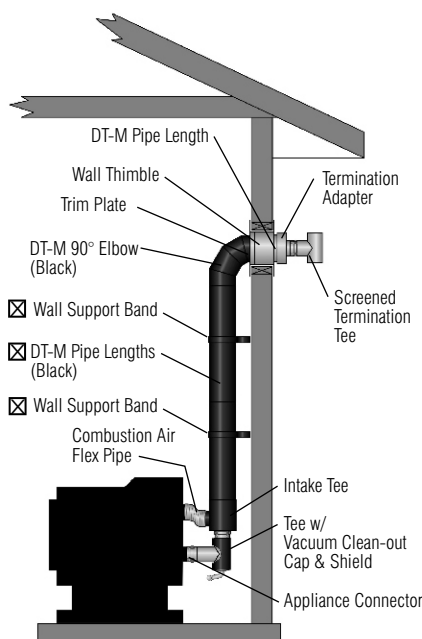

### Straight Out Installation

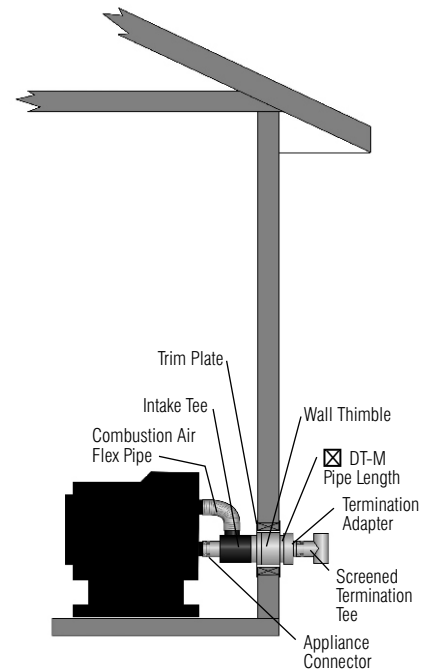

☒ = Items NOT included in Kits

# Direct-Temp® Multi-Fuel Appliance Venting Solution

## Lengths

### Straight Lengths

- Available in 6", 12", 24" and 36" lengths
- Available in galvanized or black

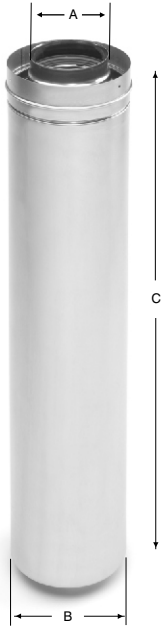

Size	Length	Dimensions			Part #	Part # (Black)
		A	B	C		
3" x 5"	6"	3"	5"	3.88"	SC03L6	SC03L6B
4" x 7"	6"	4"	7"	3.88"	SC04L6	SC04L6B

Size	Length	Dimensions			Part #	Part # (Black)
		A	B	C		
3" x 5"	12"	3"	5"	9.88"	SC03L12	SC03L12B
4" x 7"	12"	4"	7"	9.88"	SC04L12	SC04L12B

Size	Length	Dimensions			Part #	Part # (Black)
		A	B	C		
3" x 5"	24"	3"	5"	21.88"	SC03L24	SC03L24B
4" x 7"	24"	4"	7"	21.88"	SC04L24	SC04L24B

Size	Length	Dimensions			Part #	Part # (Black)
		A	B	C		
3" x 5"	36"	3"	5"	35.38"	SC03L36	SC03L36B
4" x 7"	36"	4"	7"	35.38"	SC04L36	SC04L36B

### Adjustable Lengths

- Used to adjust pipe to a non-standard length
- Adjustable from 12.5" to 19.5"
- Available in galvanized or black



Size	Length	Dimensions			Part #	Part # (Black)
		A	B	C		
3" x 5"	12.5" to 19.5"	3"	5"	12.5" to 19.5"	SC03AJ	SC03AJB
4" x 7"	12.5" to 19.5"	4"	7"	12.5" to 19.5"	SC04AJ	SC04AJB

# Direct-Temp® Multi-Fuel Appliance Venting Solution

## Elbows and Tees

### 45° Elbow

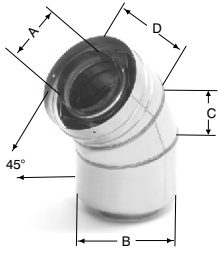

- Used to achieve offsets or changes in the direction of the vent system
- Degree of these welded seam elbows is not adjustable
- Available in galvanized or black

Size	Dimensions				Part #	Part # (Black)
	A	B	C	D		
3" x 5"	3"	5"	3.1"	3.7"	SC03E45	SC03E45B
4" x 7"	4"	7"	3.3"	4.3"	SC04E45	SC04E45B

### 90° Elbow

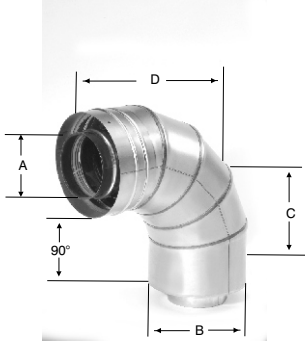

- Used to achieve offsets or changes in the direction of the vent system
- Degree of these welded seam elbows is not adjustable
- Available in galvanized or black

Size	Dimensions				Part #	Part # (Black)
	A	B	C	D		
3" x 5"	3"	5"	6.1"	7.0"	SC03E90	SC03E90B
4" x 7"	4"	7"	6.8"	7.75"	SC04E90	SC04E90B

### Air Intake Tee

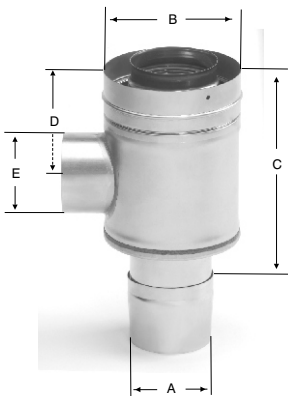

- Allows outside combustion air to be directed to the pellet stove and vents the flue gases to the outside
- Can be installed horizontally or vertically when connected to a Tee with Cleanout
- Available in galvanized or black

Size	Dimensions					Part #	Part # (Black)
	A	B	C	D	E		
3" x 5"	3"	5"	9"	4.0"	3"	SC03TAD3	SC03TAD3B
4" x 7"	4"	7"	10"	4.6"	3"	SC04TAD3	SC04TAD3B

# Direct-Temp® Multi-Fuel Appliance Venting Solution

## Elbows and Tees

### Tee w/Vacuum Cleanout Cap & Shield

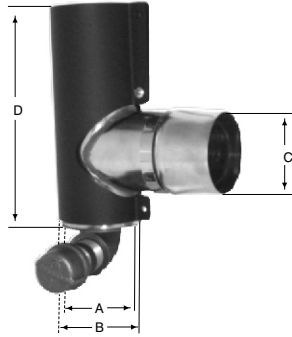

- Used to change the orientation of the vent from horizontal to vertical
- Allows any ash to be removed via a vacuum

Size	Dimensions				Part #	Part # (Black)
	A	B	C	D		
3" x 5"	3"	3.5"	3"	6.3"	N/A	9316DTMB
3" to 4"	4"	4.5"	3"	6.3"	N/A	9416DTM3B
4" x 7"	4"	4.5"	4"	7.3"	N/A	9416DTMB

## Supports

### 304 Support Clamps

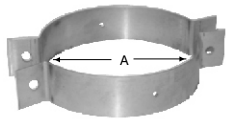

- Used with horizontal systems to provide support at the required 6-foot intervals
- Support clamps by themselves do not maintain the necessary clearances to combustible materials: be sure to consider clearances when planning the system
- Support clamps are sold in pairs to clamp around the vent and suspend from single rod or cable, or used singularly as a saddle to rest the vent in

Size	Dimensions		Part #	Part # (Black)
	A			
3" DT-M	5"		4527SS	N/A
4" DT-M	7"		4727SS	N/A

### 1" - Clear Support Clamps

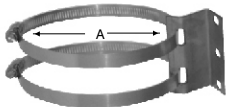

- Provides support to the DT-M system and establishes the required 1" clearance to combustible materials
- Secured in place via worm gear clamps

Size	Dimensions		Part #	Part # (Black)
	A			
3" DT-M	5"		SC03SUP1	N/A
4" DT-M	7"		SC04SUP1	N/A

# Direct-Temp® Multi-Fuel Appliance Venting Solution

## Supports

### Vertical Support Leg

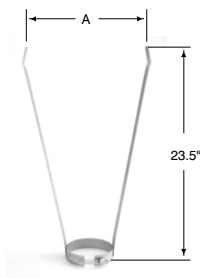

- Used to provide vertical support
- 20 gauge stainless steel support legs can be used below or above the roof

Size	Dimensions	Part #	Part # (Black)
	<b>A</b>		
3" DT-M	5"	SC03VSL	N/A
4" DT-M	7"	SC04VSL	N/A

### 1" Clear Wall Support Band

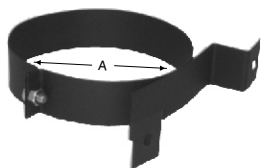

- Provides vertical or horizontal support for the DT-M system
- Provides the required minimum clearance to combustibles and is intended to be installed in locations where it would be visible

Size	Dimensions	Part #	Part # black
	<b>A</b>		
3" DT-M	5"	N/A	SC03WB
4" DT-M	7"	N/A	SC04WB

## Parts & Accessories

### Appliance Connector - Inside Fit

- Inlet end connects to the appliance and the outlet connects to the Pellet Stove Adapter or to the Tee if venting vertically

**NEW  
PHOTO  
COMING  
SOON**

Size	Dimensions			Part #	Part # (Black)
	A	B	C		
3"	2.9"	3"	4"	9363	N/A
3" to 4"	2.9"	4"	5.3"	9364	N/A
4"	3.9"	4"	4"	9464	N/A

# Direct-Temp® Multi-Fuel Appliance Venting Solution

## Parts & Accessories

### Appliance Connector - Outside Fit

- Inlet end connects to the appliance and the outlet connects to the Pellet Stove Adapter or to the Tee if venting vertically

NEW  
PHOTO  
COMING  
SOON

Size	Dimensions			Part #	Part # (Black)
	A	B	C		
3"	2.9"	3"	4"	9301MOD	N/A

### Bixby Appliance Adapter



- Provides for a direct connection between a Bixby Appliance and 3/5 DT-M product

Size	Dimensions		Part #	Part # (Black)
	A			
3/5"	4"		SC03AD08	N/A

### Firestop for 1" Clearance

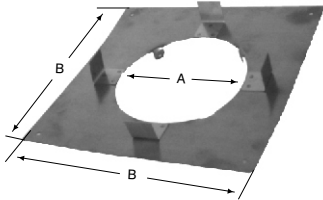

- Required any time the DT-M vent penetrates a combustible ceiling

Size	Dimensions		Part #	Part # (Black)
	A	B		
3" DT-M	5.06"	9"	SC03AFSP	N/A
4" DT-M	7.06"	11"	SC04AFSP	N/A

### Trim Plate

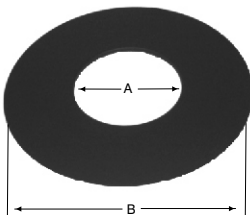

- Used to provide a finished look at the ceiling for vertical installations

Size	Dimensions		Part #	Part # (Black)
	A	B		
3" DT-M	5.13"	12"	SC03TP	N/A
4" DT-M	7.13"	14"	SC04TP	N/A

# Direct-Temp® Multi-Fuel Appliance Venting Solution

## Parts & Accessories

### Wall Thimble

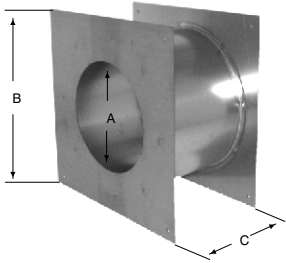

- Used when the vent pipe passes through a wall

Size	Dimensions			Part #	Part # (Black)
	A	B	C		
3" DT-M	5.06"	9"	4.5" to 7"	SC03WT	N/A
4" DT-M	7.06"	11"	4.5" to 7"	SC04WT	N/A

NOTE: add SUSI to this part for increased performance and safety

### SUSI - Selkirk Universal Shielding Insulation

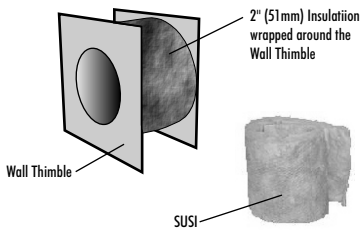

- Insulation used with Wall Thimble for increased performance and safety

Size	Dimensions			Part #	Part # (Black)
	Universal				
Universal				SUSI	N/A

### Roof Flashings

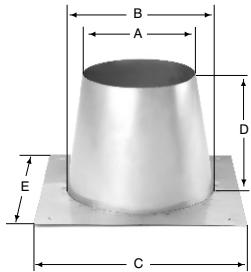

- Used as a vertical roof penetration and support for flat roof installations
- Must be installed with a Storm Collar (ordered separately)

Size	Dimensions					Part #	Part # (Black)
	A	B	C	D	E		
3" DT-M	5.5"	7.5"	12.5"	6.0"	Flat to 2/12 Pitch	SC03TCF	N/A
3" DT-M	5.5"	7.5"	12.5"	6.0"	2/12 to 6/12 Pitch	SC03TCFA	N/A
3" DT-M	5.5"	7.5"	12.5"	6.0"	6/12 to 12/12 Pitch	SC03TCFB	N/A
4" DT-M	7.5"	9.5"	14.5"	6.0"	Flat to 2/12 Pitch	SC04TCF	N/A
4" DT-M	7.5"	9.5"	14.5"	6.0"	2/12 to 6/12 Pitch	SC04TCFA	N/A
4" DT-M	7.5"	9.5"	14.5"	6.0"	6/12 to 12/12 Pitch	SC04TCFB	N/A

### 304 Storm Collar

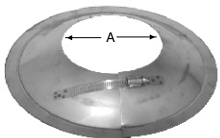

- Used with the Tall Cone Flashing or other roof flashing to provide support to vertical installations
- May be tightened and sealed around the vent to prevent water from entering the building
- Made from Type 304 Stainless Steel

Size	Dimensions			Part #	Part # (Black)
	A				
3" DT-M	5"			4526SS	N/A
4" DT-M	7"			4726SS	N/A



# Direct-Temp® Multi-Fuel Appliance Venting Solution

## Outside the House Parts

### 4DT-CAK Combustion Air Kit



- Provides an avenue for combustion air to flow from the Pellet Stove Adapter to the combustion air inlet of the appliance
- Includes 36" length of Aluminum Flex and Hose Clamp

Size	Length	Part #	Part # (Black)
3"	A 3'	4DT-CAK	N/A

### Tall Rain Cap

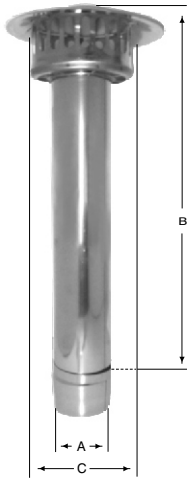

- Used as a termination for vertical systems
- Prevents rain water from entering the vent
- Available in galvanized or black

Size	Dimensions			Part #	Part # (Black)
	A	B	C		
3" DT-M	3"	17.5"	5"	SC03RCX	N/A
4" DT-M	4"	18.3"	7"	SC04RCX	N/A

### Termination Adapter

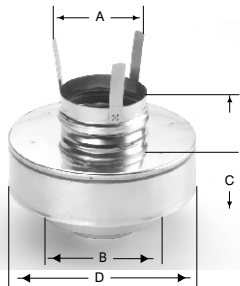

- Terminates the system
- Includes intake for combustion air

Size	Dimensions				Part #	Part # (Black)
	A	B	C	D		
3" DT-M	3"	5"	3.8"	7.1"	SC03VT	N/A
4" DT-M	4"	7"	3.8"	9.1"	SC04VT	N/A

## Outside the House Parts

### Free Flow Horizontal Termination Cap

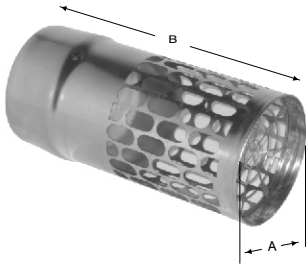

- Used as a termination on horizontal systems

Size	Dimensions		Part #	Part # (Black)
	A	B		
3" DT-M	3"	6.25"	9390FFHT	N/A
4" DT-M	4"	7.25"	9490FFHT	N/A

### Screened Termination Tee

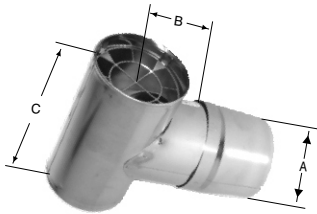

- Used as a termination on horizontal or vertical systems

Size	Dimensions			Part #	Part # black
	A	B	C		
3" DT-M	3"	5.5"	6"	9390TEE	N/A
4" DT-M	4"	6.0"	7"	9490TEE	N/A

### 45° Screened Termination Elbow

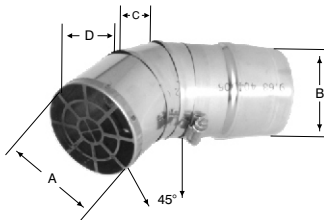

- Used as a termination on horizontal or vertical systems

Size	Dimensions				Part #	Part # (Black)
	A	B	C	D		
3" DT-M	3"	3.8"	5.3"	6.8"	9311TERM	N/A
4" DT-M	4"	5.3"	6"	8.0"	9411TERM	N/A

### 90° Screened Termination Elbow

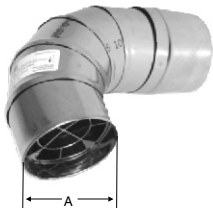

- Used to terminate a horizontal system
- Directs the exhaust down

Size	Dimensions		Part #	Part # (Black)
	A			
3" DT-M	3"		9314TERM	N/A
4" DT-M	4"		9414TERM	N/A

# Direct-Temp® Multi-Fuel Appliance Venting Solution

## Support Kits

### Selkirk has put together 3 DT-M kits to get your project done . . .

We have taken the guess work out of installation by putting the most common parts for each installation all in one box. These 3 kits depict the most common installations. Simply decide which of these scenarios fits your need, then pick up your Direct-Temp lengths and if required the proper roof flashing

### Vertical Kit

When your chimney goes up through a ceiling, then thru the roof, you'll need the VERTICAL KIT - \*DTM-VK which includes:

- Tee with Vacuum Cleanout Cap & Shield
- Air Intake Tee - Black
- Firestop
- Trim Plate
- Appliance Adapter
- 304 Storm Collar
- Termination Adapter
- Tall Rain Cap
- Combustion Air Kit

**SIZE**

3"  
4"

**PRODUCT CODE**

3DTM-VK  
4DTM-VK

*Now just add:*

**DT-M Lengths** available in 6", 12", 24" and 36" lengths and the appropriate **Roof Flashing**  
Flat-2/12  
2/12 - 6/12  
6/12 - 12/12

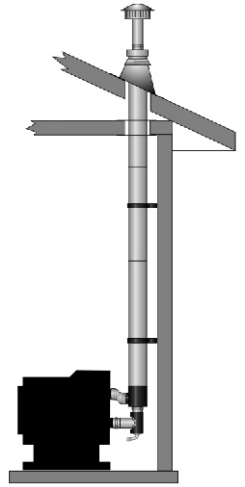

### Up & Out Kit

When your chimney goes up and then out the wall you'll need the Up & Out KIT - \*DTM-UK which includes:

- Tee with Vacuum Cleanout Cap & Shield
- Air Intake Tee - Black
- 90° Elbow - Black
- Trim Plate
- Wall Thimble
- Appliance Adapter
- Termination Adapter
- Screened Termination Tee
- Combustion Air Kit

**SIZE**

3"  
4"

**PRODUCT CODE**

3DTM-UK  
4DTM-UK

*Now just add:*

**DT-M Lengths** available in 6", 12", 24" and 36" lengths

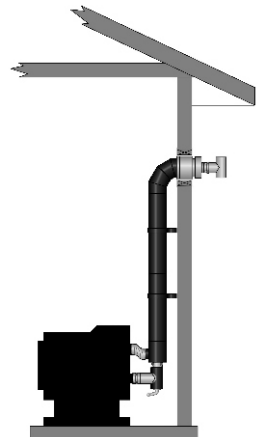

### Horizontal Kit

When your chimney goes straight out the wall you'll need the HORIZONTAL KIT - \*DTM-HK which includes:

- Air Intake Tee - Black
- Trim Plate
- Wall Thimble
- Appliance Adapter
- Termination Adapter
- Screened Termination Tee
- Combustion Air Kit

**SIZE**

3"  
4"

**PRODUCT CODE**

3DTM-HK  
4DTM-HK

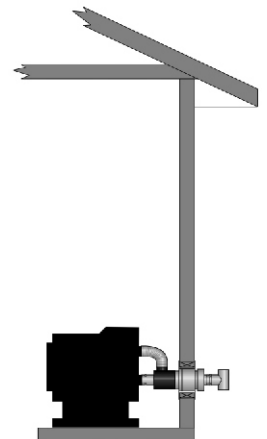



## The Best Warranty in the Industry

Direct-Temp for Multi-Fuel features advanced engineering designs and premium materials which allow us to offer a Lifetime Warranty.

See written warranty for details.

## All Hearth Products Are Not Created Equal.



**Flexible Aluminum Chimney Liners**



**Stainless Steel Chimney Liners**



**Pellet-Pipe**



**Insulated Chimney Systems**



**Stove Pipe**



**Direct Vent Pipe  
for Gas, Pellet, or Multi Fuel**



*Reduce, Reuse, Recycle*  
Our literature is printed on  
recyclable paper



### SELKIRK CANADA CORPORATION

375 Green Road, Stoney Creek,  
ON L8E 4A5

TEL: 1.888.SELKIRK (735-5475) • FAX: 1.866.835.9624

[www.selkirkcorp.com](http://www.selkirkcorp.com)

email: [info@selkirkcorp.com](mailto:info@selkirkcorp.com)

### SELKIRK CORPORATION

1301 West President Bush Hwy., Suite 330,  
Richardson, TX 75080

TEL: 1.800.992.VENT (8368) • FAX: 1.877.393.4145