

# - AGP Pellet Stove -

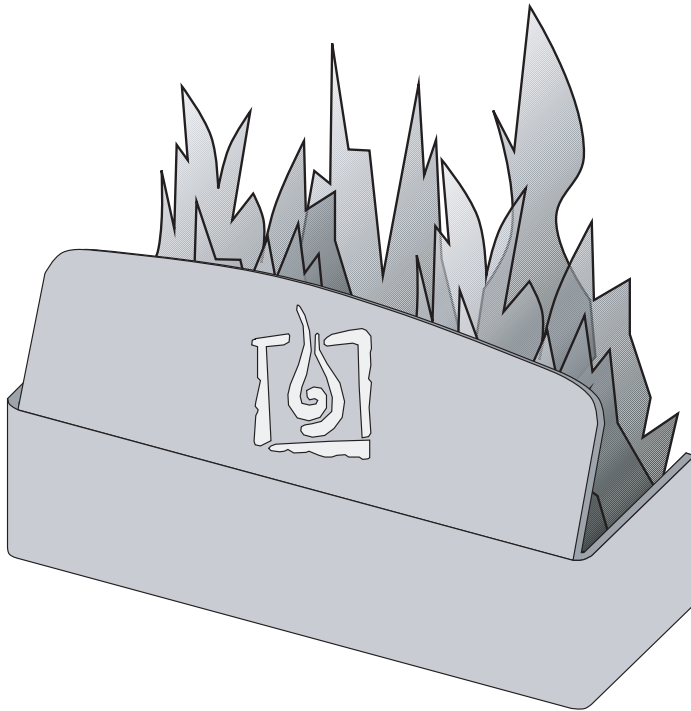

## TRAVIS INDUSTRIES HOUSE OF FIRE



- *Horizontal or Vertical Vent*
- *Freestanding Stove*
- *Mobile Home Approved*
- *Class A Chimney Retrofit*
- *Hearth Stove into Existing Masonry Chimney, Masonry Fireplace, or Z.C. Fireplace*

- **Please read this entire manual before installation and use of this pellet fuel-burning room heater. Failure to follow these instructions could result in property damage, bodily injury, or even death.**
- **Contact local building or fire officials about restrictions and installation inspection requirements in your area.**
- **Save these instructions.**



**Installer:** After installation give this manual to the homeowner and explain operation of this stove.

**Consumer:** Retain this manual for future reference.

\$10.00 © Copyright 2014, T.I.  
Part # 100-01270 4140421

**Travis Industries, Inc.**

www.travisproducts.com  
12521 Harbour Reach Drive SW  
Mukilteo, WA 98275



<b>Introduction</b> .....	<b>2</b>	To Adjust Heat Output.....	24
<b>Important Information</b> .....	<b>2</b>	Auto-Fan .....	24
<b>Heating Specifications</b> .....	<b>7</b>	<b>TSTAT (Thermostat) Mode</b> .....	<b>25</b>
<b>Dimensions</b> .....	<b>7</b>	To Start the Stove in TSTAT Mode .....	25
<b>Electrical Specifications</b> .....	<b>7</b>	To Adjust the Heat Output.....	25
<b>Fuel</b> .....	<b>7</b>	To Shut Down .....	25
<b>EPA Compliance</b> .....	<b>7</b>	Changing the TSTAT Program.....	26
<b>Before You Begin</b> .....	<b>8</b>	How to Tell Which TSTAT Program You Are In.....	26
<b>Packing List</b> .....	<b>8</b>	Switching Between Program 1, 2, and 3.....	26
<b>Items Required</b> .....	<b>8</b>	Thermostat Program 1 .....	26
<b>Installation Options</b> .....	<b>8</b>	Thermostat Program 2 .....	26
<b>Planning the Installation</b> .....	<b>9</b>	Thermostat Program 3 .....	26
<b>Stove Placement</b> .....	<b>9</b>	<b>Start-Up Sequence (Igniter)</b> .....	<b>27</b>
<b>Floor Protection Requirements</b> .....	<b>9</b>	<b>Power Outages</b> .....	<b>27</b>
<b>Electrical Requirements</b> .....	<b>9</b>	Manual Mode .....	27
<b>Clearances</b> .....	<b>10</b>	TSTAT Mode.....	27
Straight Installations.....	10	<b>Stove Maintenance</b> .....	<b>28</b>
Corner Installations .....	10	Maintenance Schedule .....	28
<b>Venting the Pellet Stove</b> .....	<b>11</b>	Removing Flyash .....	28
Maximum Venting Distance .....	11	Disposal of Ashes .....	28
Pellet Vent Type.....	12	Stove Maintenance Tools .....	29
Installing the Pellet Vent .....	12	Stove Tool Storage .....	29
Pellet Vent Termination.....	12	Opening the Door.....	29
<b>Mobile Home Requirements</b> .....	<b>13</b>	Weekly Maintenance (or Every 5 Bags of Pellets) - Inspect the Burn.....	30
<b>Outside Air (Used for Combustion – Use Part #99200136)</b> .....	<b>13</b>	Weekly Maintenance (or Every 5 Bags of Pellets) - Clean the Fire Platform .....	30
<b>Alcove Installation Requirements</b> .....	<b>14</b>	Weekly Maintenance (or Every 5 Bags of Pellets) - Clean the Heat Exchange Tubes .....	33
<b>Restrictor Adjustment</b> .....	<b>14</b>	Cleaning Behind the Firebox Liners .....	34
<b>Installation Examples</b> .....	<b>15</b>	Monthly Maintenance (or Every 20 Bags of Pellets) - Clean the Glass .....	35
Installation Example: Direct "Through-the-wall" Installation .....	15	Monthly Maintenance (or Every 20 Bags of Pellets) – Empty the Ashpan.....	36
Installation Example: Interior Vertical Installation	16	Yearly Maintenance (or Every Ton of Pellets) - Clean the Lower Exhaust Duct.....	37
Installation Example: Class "A" Chimney Retrofit	17	Yearly Maintenance (or Every Ton of Pellets) - Clean the Convection Blower.....	39
Installation Example: Masonry Fireplace Hearth Stove.....	18	Yearly Maintenance (or Every Ton of Pellets) - Clean the Negative Pressure Tube .....	40
Installation Example: Zero-Clearance (Metal) Fireplace Hearth Stove .....	19	Yearly Maintenance (or Every Ton of Pellets) - Clean the Vent .....	40
Installation Example: Freestanding Masonry Chimney.....	20	Yearly Maintenance (or Every Ton of Pellets) - Adjust the Latch .....	41
<b>Safety Notice</b> .....	<b>21</b>	Yearly Maintenance (or Every Ton of Pellets) - Check for Air Leaks Around the Door, Glass, and Ashpan.....	41
<b>Location of Controls</b> .....	<b>21</b>	<b>Troubleshooting Table</b> .....	<b>42</b>
<b>Loading Pellets</b> .....	<b>22</b>	Diagnostic Codes.....	42
<b>Starting the Heater for the First Time</b> .....	<b>22</b>	<b>Wiring Diagram</b> .....	<b>43</b>
Curing the Paint .....	22	<b>Wireless Thermostat Installation (Optional)</b> .....	<b>44</b>
<b>Manual Mode</b> .....	<b>23</b>		
To Start .....	23		
To Shut Down .....	23		
To Adjust the Heat.....	23		

# Safety Precautions



**HOT WHILE IN OPERATION.  
KEEP CHILDREN, CLOTHING,  
AND FURNITURE AWAY.  
CONTACT MAY CAUSE SKIN  
BURNS.**

Educate all children of the danger of a high-temperature heater. Young children should be supervised when they are in the same room as the heater.



Contact your local building officials to obtain a permit and information on any installation restrictions or inspection requirements in your area. Notify your insurance company of this appliance as well.



Do not operate the heater if you smell smoke coming from the heater. Turn the MODE switch to "OFF", monitor your heater, and call your dealer.



Never use gasoline, gasoline-type lantern fuel, kerosene, charcoal lighter fluid, or similar liquids to start or "freshen up" a fire in this heater. Keep all such liquids well away from the heater while it is in use.



Do not unplug the heater if you suspect a malfunction. Turn the MODE SWITCH to "OFF" and periodically inspect the heater.



Ashes should be placed in a metal container with a tight-fitting lid. The closed container of ashes should be placed on a noncombustible floor or on the ground, well away from all combustible materials, pending final disposal. If the ashes are disposed of by burial in soil or otherwise locally dispersed, they should be retained in the closed container until all cinders have been thoroughly cooled.



Never try to repair or replace any part of the heater unless instructions are given in this manual. All other work should be done by a trained technician.



The viewing door and ashpan must be closed and latched during operation.



This unit must be properly installed to prevent the possibility of a house fire. The instructions must be strictly adhered to. Do not use makeshift methods or compromise in the installation.



This heater is designed and approved for pelletized wood fuel only.

# Safety Precautions

5

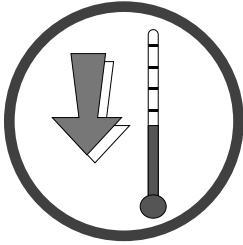

Allow the appliance to cool completely before carrying out any maintenance or cleaning.



Maintain the door and glass seal and keep them in good condition. Do not operate this heater with broken or missing glass. Do not slam the door or strike the glass.

Notify your dealer to replace the glass if glass on this appliance is broken or damaged.



Do not operate the heater if the flame becomes dark & sooty or if the fire platform overfills with pellets. Turn the MODE SWITCH to OFF and periodically inspect the heater (see "Operating Your Heater – Manual Mode").

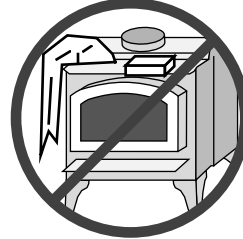

Do not place clothing or other flammable items on or near this appliance.



The heater will not operate during a power outage.



This heater must be connected to a standard 115 V., 60 Hz grounded electrical outlet. Do not use an adapter plug or sever the grounding plug. Do not route the electrical cord underneath, in front of, or over the heater.



Keep foreign objects out of the hopper.



The exhaust system must be completely airtight and properly installed. The pellet vent joints must be sealed with RTV 500° F. (260° C.) silicone sealant.



Your heater requires periodic maintenance and cleaning (see "Stove Maintenance"). Failure to maintain your heater may lead to accumulation of soot, creosote, and ash, and smoke spillage or fire in your home.



When installed in a mobile home, the heater must be bolted to the floor, have outside air, and **NOT BE INSTALLED IN THE BEDROOM** (per H.U.D. requirements). Check with local building officials.

# Safety Precautions



Do not throw this manual away. This manual has important operating and maintenance instructions that you will need at a later time. Always follow the instructions in this manual.



Disconnect the power before performing any maintenance.



The exhaust system should be checked at least twice a year for any build-up of soot or creosote.



Travis Industries, Inc. grants no warranty, implied or stated, for the installation or maintenance of your appliance, and assumes no responsibility of any consequential damage(s).

**DO NOT INSTALL A FLUE DAMPER IN THE EXHAUST VENTING SYSTEM OF THIS UNIT.**

**DO NOT CONNECT THIS UNIT TO A CHIMNEY FLUE SERVING ANOTHER APPLIANCE.**

**INSTALL VENT AT CLEARANCES SPECIFIED BY THE VENT MANUFACTURER.**

***Soot and Flyash: Formation and Need for Removal*** – The products of combustion will contain small particles of flyash. The flyash will collect in the exhaust venting system and restrict the flow of the flue gases. Incomplete combustion, such as occurs during startup, shutdown, or incorrect operation of the room heater will lead to some soot formation which will collect in the exhaust venting system. The exhaust venting system should be inspected at least once every year to determine if cleaning is necessary.

**NEVER USE SUBSTITUTE MATERIALS FOR ANY PURPOSE ON THIS APPLIANCE.**

Establish a routine for fuel, wood burner and firing technique. Check for creosote build-up daily until you know how often to clean the appliance for safe operation. Be aware that the hotter the fire, the less creosote is deposited, and weekly cleaning may be necessary in mild weather even though monthly cleaning may be enough in the coldest months. Contact your municipal or provincial fire authority for information on how to handle a chimney fire. Have a clearly understood plan in place for how to handle a chimney fire.

Do not burn this stove if unburned pellets are in the ashpan. These should be removed as they may ignite.

## Heating Specifications

---

Approximate Maximum Heating Capacity (in square feet)* .....	800 to 2,000 Sq. Feet
BTUs .....	11,480 to 41,000 **
Burn Rate (Pounds per Hour)*** .....	1.4 to 5
Maximum Burn Time on Low Burn*** .....	57 Hours
Hopper Capacity .....	80 Pounds
Turn-Down Ratio .....	72%

\* Heating capacity will vary depending on the home's floor plan, degree of insulation, and the outside temperature. It is also affected by the fuel size, quality, and moisture level.

\*\* Based on 8,200 BTUs per pound.

\*\*\* Small pellet size will decrease the stated burn rates and burn times. Differences of plus or minus 20% depending on fuel quality may occur.

## Dimensions

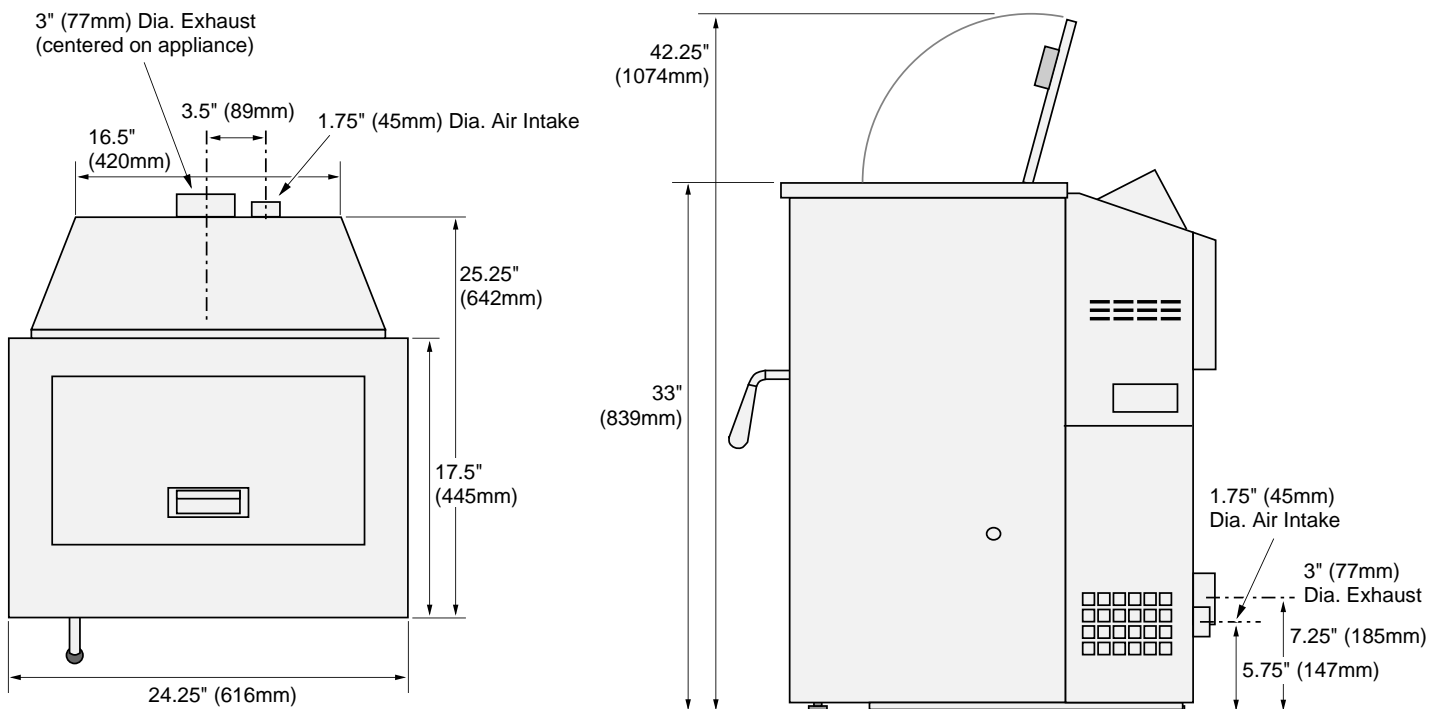

## Electrical Specifications

---

Electrical Rating .....	115 Volts, 3 Amps, 60 Hz
Watts during Start-Up Sequence .....	350 (approximately)
Watts during Operation .....	250 (approximately)

## Fuel

This heater is designed and approved for pelletized wood fuel only (all grades).

## EPA Compliance

This heater has been tested exempt from EPA Phase II Requirements.

## ***Before You Begin***

---

**READ THIS ENTIRE MANUAL BEFORE YOU INSTALL AND USE THIS HEATER. FAILURE TO FOLLOW THE INSTRUCTIONS MAY RESULT IN PROPERTY DAMAGE, BODILY INJURY, OR EVEN DEATH.**

Check with local building officials for any permits required for installation of this pellet heater and notify your insurance company before proceeding with installation.

## ***Packing List***

---

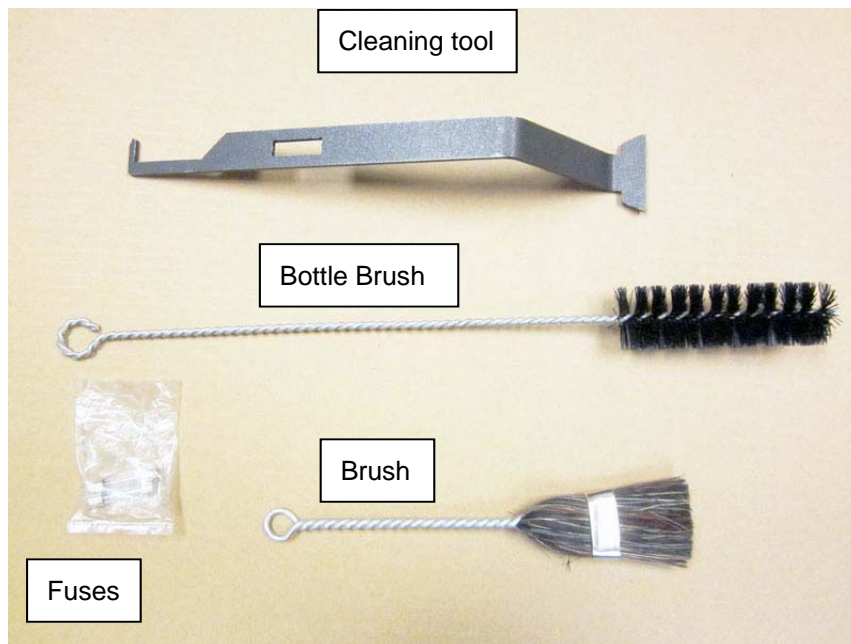

## ***Items Required***

---

- AGP Pellet Stove Door (SKU 96100793 or 96100774)
- AGP Pellet Stove Side Panels (SKU 94400024, 94400025, or 94400026)

## ***Installation Options***

---

- Residential or Mobile Home (see the section "Mobile Home Requirements")
- Alcove Compatible (see the section "Alcove Installation")
- Horizontal or Vertical Vent
- Outside Air Compatible
- Vent with L-Vent, L-Vent Fireplace Liner, or Type "A" Chimney (with adapter)



## Planning the Installation

---

- HINT: Have an authorized Travis Industries dealer install this heater. If you install the heater yourself, have your dealer review your installation plans.
- HINT: Sketch out a detailed plan of the installation including dimensions. Then verify the dimensions with the requirements listed in this manual.
- HINT: When determining the location of the stove, locate the wall studs (for horizontal penetrations) and ceiling trusses (for vertical penetrations). You may wish to adjust the stove position slightly to ensure the vent does not intersect with a framing member.

## Stove Placement

---

- Stove must be placed so that no combustibles are within, or can swing within (e.g. drapes, doors), 36" (915mm) of the front of the heater.
  - If the stove is placed in a location where the ceiling height is less than 7' (2.134 M), it must follow the requirements in the section "Alcove Installation Requirements".
- HINT: **REDUCING CLEARANCES** - Clearances may be reduced by methods specified in NFPA 211, listed wall shields, pipe shields, or other means approved by local building or fire officials.
- Heater and floor protection must be installed on a level, secure floor.

## Floor Protection Requirements

---

- The heater must be installed on a non-combustible floor protector extending the full width and depth of the heater and extending 6" (153mm) in front (minimum .018" thick - 26 gauge).
- Must extend under and 2" (51mm) to each side and rear of a "Tee" (if used).

## Electrical Requirements

---

- This heater **requires** a standard 120 volt, 60 Hz **grounded** electrical outlet. Do not use an adapter plug or sever the grounding plug.
- This heater **requires correct polarity**. The line (hot) is on the right and has a smaller plug. The neutral (common) is on the left and has a larger plug. Use a circuit tester (available at hardware stores) or contact an electrician to verify correct polarity and ground.

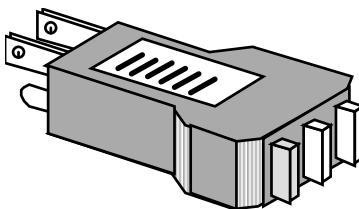

**WARNING:** Connection to a reverse polarity or un-grounded circuit may damage your heater's circuit board. This may cause a safety hazard, improper operation, and void your warranty.

- Do not route the electrical cord underneath, in front of, or over the heater.

## Clearances

### Straight Installations

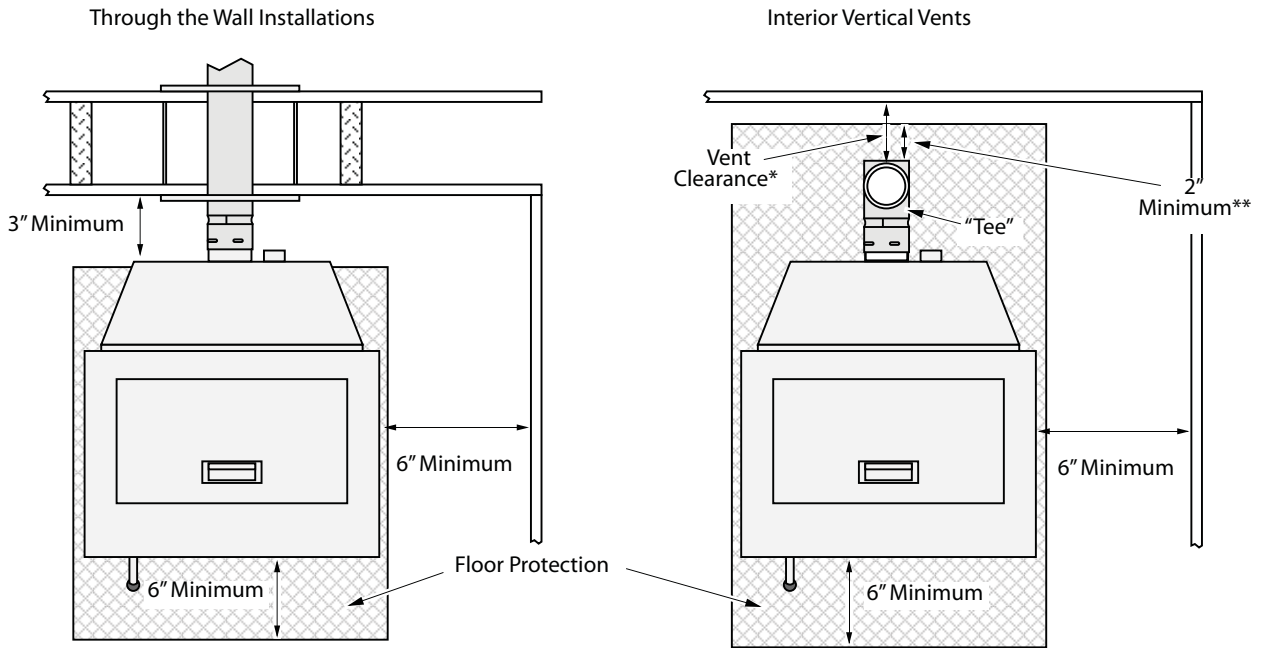

### Corner Installations

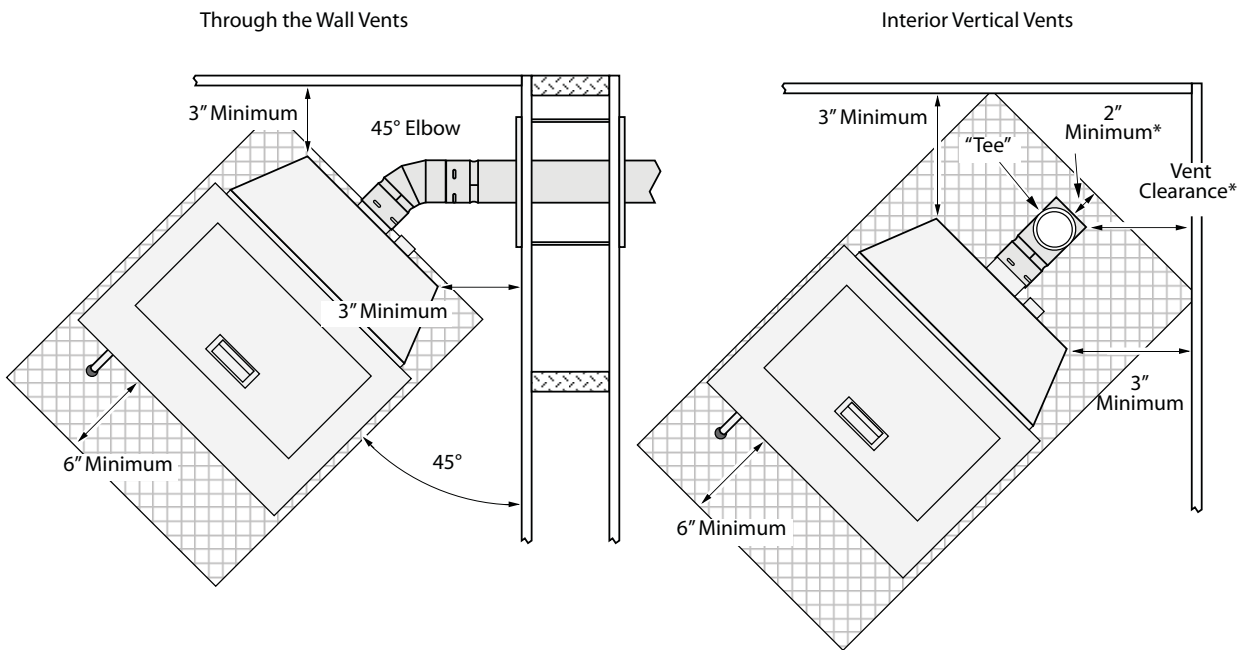

- \* **Install the vent at the clearance specified by the vent manufacturer.**  
**NOTE:** If an interior vertical vent is used, the stove to backwall dimension is determined by the vent being used. This dimension will vary depending on the brand of pellet vent used. To determine the distance from the backwall to the stove, connect the "Tee" and add the vent clearance.
- \*\* The floor protection must extend 2" (51mm) beyond the pipe – all vent clearances must be met.

## Venting the Pellet Stove

- **INSTALL VENT AT CLEARANCES SPECIFIED BY THE VENT MANUFACTURER.**
- **DO NOT CONNECT THE PELLET VENT TO A VENT SERVING ANY OTHER APPLIANCE OR STOVE.**
- **DO NOT INSTALL A FLUE DAMPER IN THE EXHAUST VENTING SYSTEM OF THIS UNIT.**
- **USE AN APPROVED WALL THIMBLE WHEN PASSING THE VENT THROUGH WALLS AND A CEILING SUPPORT/FIRE STOP SPACER WHEN PASSING THE VENT THROUGH CEILINGS (MAKE SURE TO MAINTAIN CLEARANCE TO ANY COMBUSTIBLES).**
- No more than one tee and 180° of elbows (one tee with two 90° elbows, one tee with one 90° and two 45° elbows, etc.).

### Maximum Venting Distance

- Vent must have a support bracket every 5' (1.524 M) of pellet vent when on exterior of structure.

NOTE: Travis Industries recommends a minimum vertical vent of 5' to ensure adequate draft during a power outage.

The vent height and run must not exceed the distance shown in the shaded region shown to the right.

Venting into this shaded area may require restrictor adjustments. See the section "Restrictor Adjustment" for details.

NOTE: To achieve optimum performance, we recommend keeping the vent as short as possible (horizontal run especially).

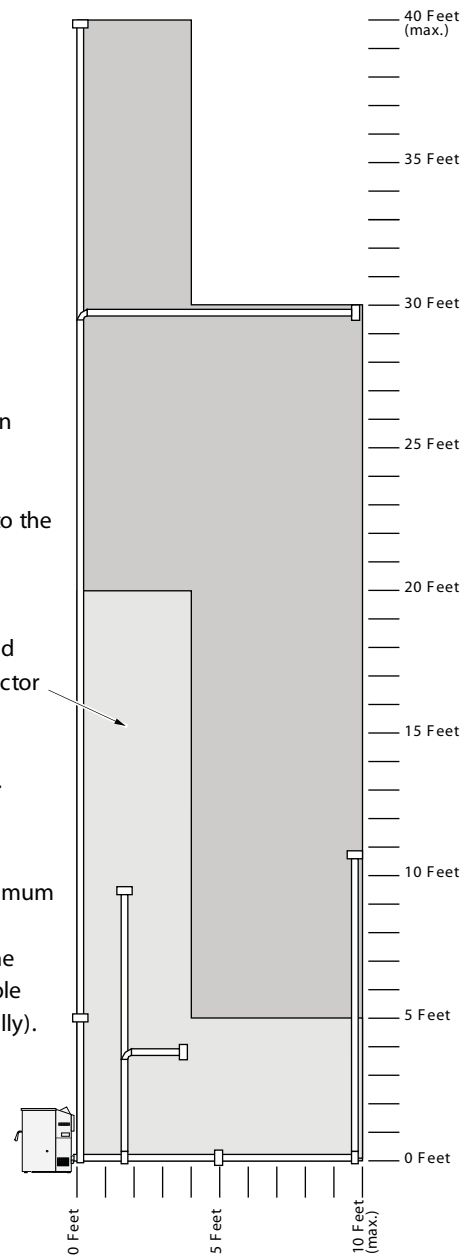

## Pellet Vent Type

- Must be 3" (76mm) or 4" (102mm) diameter Type "L" (except for masonry fireplace installations) - or - connect the vent to a factory built type "A" chimney. All vent joints (including adapters, elbows, etc.) must be sealed (typically 500° F. RTV silicone is used).

## Installing the Pellet Vent



Seal each vent section (including adapters, elbows, etc...) by injecting a liberal amount of 500° F. RTV silicone into the gap between sections.

Install the vent at the clearance specified by the vent manufacturer.

- Horizontal sections must have a 1/4" (6.4mm) rise every 12" (305mm) of travel.
- Pellet vent connections must be sealed airtight with 500° F. RTV silicone and screwed together with at least 3 sheet metal screws (unless the vent manufacturer's requirements specify otherwise).

## Pellet Vent Termination

- Vent must terminate on the exterior of the dwelling. Horizontal terminations must protrude a minimum of 12" (305mm) from the wall. Vertical terminations must protrude a minimum 24" (610mm) from the roof surface. In addition, all clearances listed below must be met.
- Must have an approved cap (to prevent water from entering) or a 45° downturn with rodent screen.
- If the termination is located on a windy side of the house, an approved house shield is recommended to prevent soot from building up on the side of the house.
- Must not be located where it will become plugged by snow or other material.

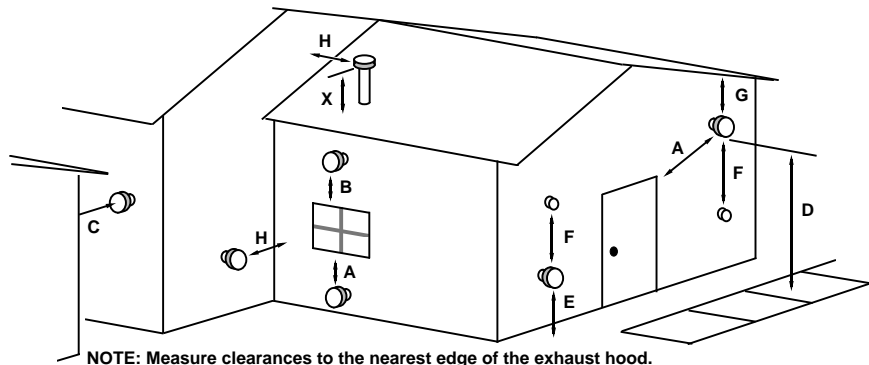

- A Minimum 4' (1220mm) clearance below or beside any door or window that opens. (This clearance may be reduced to 18" if using outside air (see page 13) – we recommend the door or window be kept closed during operation.)
  - B Minimum 1' (458mm) clearance below or beside any window that does not open.
  - C Minimum 2' (610mm) clearance from any adjacent building
  - D Minimum 7' (2.134 M) clearance above any grade when adjacent to public walkways
- NOTE:** Vent may not terminate in covered walkway or breezeway.
- E Minimum 2' (610mm) clearance above any grass, plants, or other combustible materials
  - F Minimum 3' (915mm) clearance from any forced air intake of any other appliance
  - G Minimum 2' (610mm) clearance below eaves or overhangs
  - H Minimum 1' (458mm) clearance horizontally from combustible wall
  - X Must be a minimum of 2' (610mm) above the roof

## Mobile Home Requirements

- Outside air is required (used for combustion) - see the directions below.
- The heater must be bolted to the floor (Some states do not require this; check with your local building department).
- The heater must be grounded to the steel chassis of the mobile home (Some states do not require this; check with your local building department).



**DO NOT INSTALL IN SLEEPING ROOM.**

**CAUTION:**

**THE STRUCTURAL INTEGRITY OF THE MANUFACTURED HOME FLOOR, WALL, AND CEILING/ROOF MUST BE MAINTAINED.**

## Outside Air (Used for Combustion – Use Part #99200136)

- Must not be drawn from an enclosed space (garage, unventilated crawl space).  
**HINT:** Travis Industries strongly recommends outside air for all residential installations, especially for those that are energy efficient, air-tight homes.
- Must not be over 48" (1220mm) long
- Must be made with 1- $\frac{3}{4}$ " (45mm) diameter or larger metal or aluminum duct with a metal screen attached to the end to keep out rodents (P.V.C. or other combustible materials may not be used). We recommend the Travis Industries Outside Air Kit (part # 99200136).
- Must not terminate above or within 1' (305mm) of the chimney termination.
- Must have a rain cap or down-turned elbow to prevent water from entering.
- Must be located so that it will not become plugged by snow or other material.

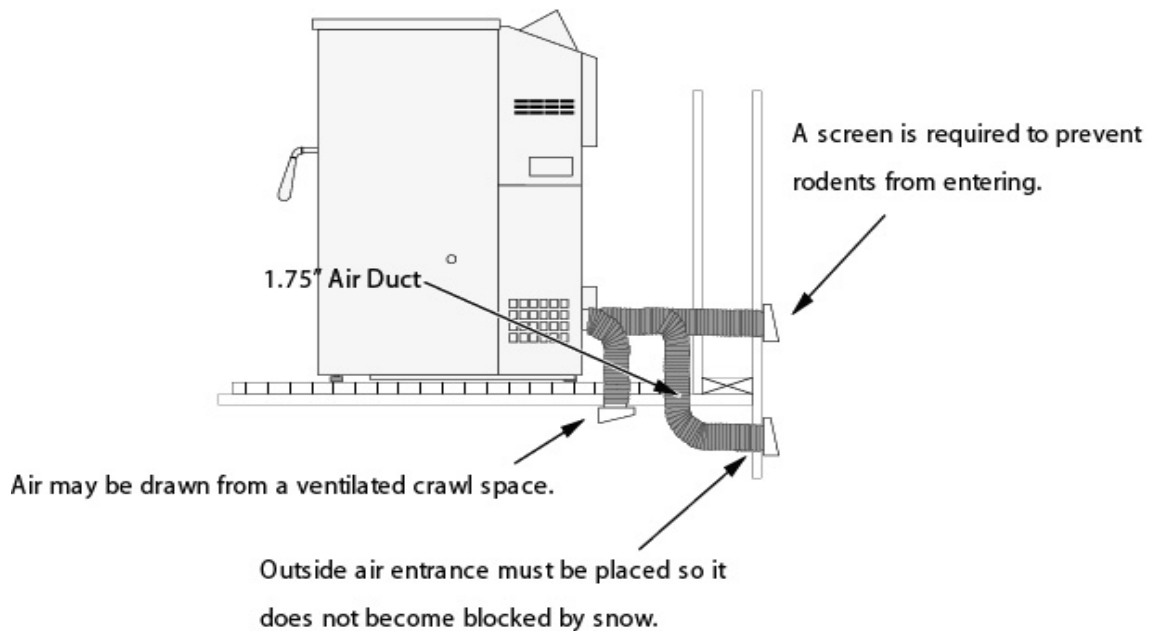

## Alcove Installation Requirements

When the pellet stove is placed in a location where the ceiling height is less than 7' (2.134 M) tall, it is considered an alcove installation. Because of the reduced height, the requirements listed below must be met.

- Minimum height is 60"
- Minimum width is 36-9/16"
- Maximum depth is 48"
- Minimum clearance of 6" on each side and 3" on back
- Minimum clearance of 3" for horizontal venting
- Minimum clearance of 2" from pipe for vertical venting

## Restrictor Adjustment

For installations with a tall flue, the restrictor may be needed to adjust airflow to the fire platform. This keeps the fire platform and glass as clean as possible.

**For low heat output settings** the restrictor may need to be closed or near closed to limit the amount of air. This prevents the stove from burning the pellet fuel faster than it is fed.

**For medium heat output settings** the restrictor may need to be opened to a medium position.

**For high heat output settings** the restrictor will need to be opened to a high position. This prevents the fire platform from over-filling with pellets and becoming clogged with ash clumps.

Keeping your fire platform clean is the most important step to maintaining a safe and efficient stove. Check and clean your fire platform daily until you find the correct restrictor settings and appropriate fire platform cleaning interval.

### Not Enough Air

If clinkers (ashes that solidify into a clump) develop or the flame appears lazy and slow to blow the ash out of the fire platform, push the restrictor in until the flame becomes active and the fire platform holes remain clean.

**NOTE:** If the restrictor is fully in, yet the fire platform does not remain clean, the stove needs to be cleaned and checked for air leaks (see "Maintenance" section of this manual).

### Too Much Air

If the flames are too active (small, flickering flames), move the restrictor rod out until the flame slows down.

**NOTE:** It is acceptable to have "glowing embers" jump out of the fire platform. Another symptom of too much air is the heater "blowing the fire out" – a condition in which the pellets burn faster than they are fed (this is most common on low heat settings).

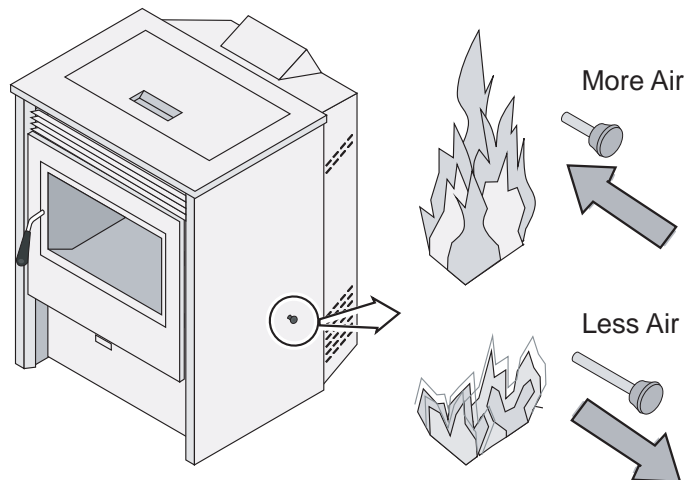

## Installation Examples

### Installation Example: Direct "Through-the-wall" Installation

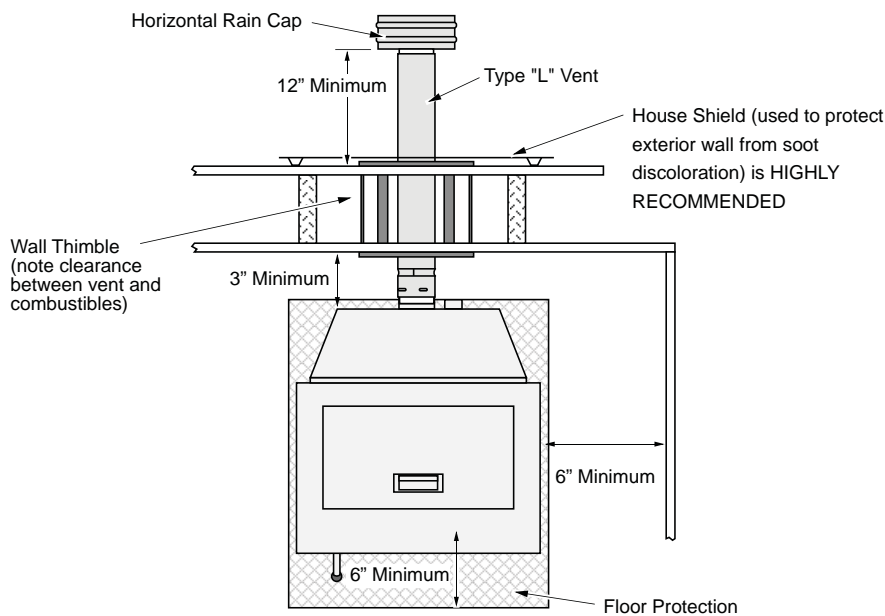

Seal each vent section (including adapters, elbows, etc...) by injecting a liberal amount of 500° F. RTV silicone into the gap between sections, unless otherwise specified by the manufacturer.

A small diagram showing a tube of 500° F. RTV Silicone being applied to the gap between two vent pipe sections.

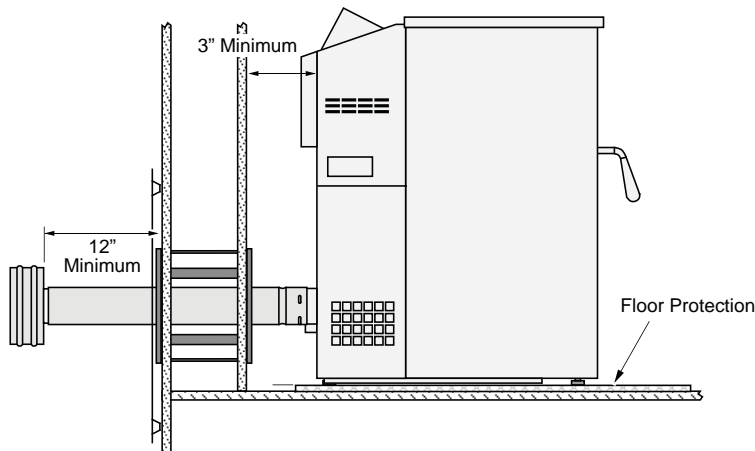

**NOTE:** Travis Industries recommends a minimum vertical vent of 5' to ensure adequate draft during a power outage.

**Install the vent at the clearance specified by the vent manufacturer.**

## Installation Example: Interior Vertical Installation

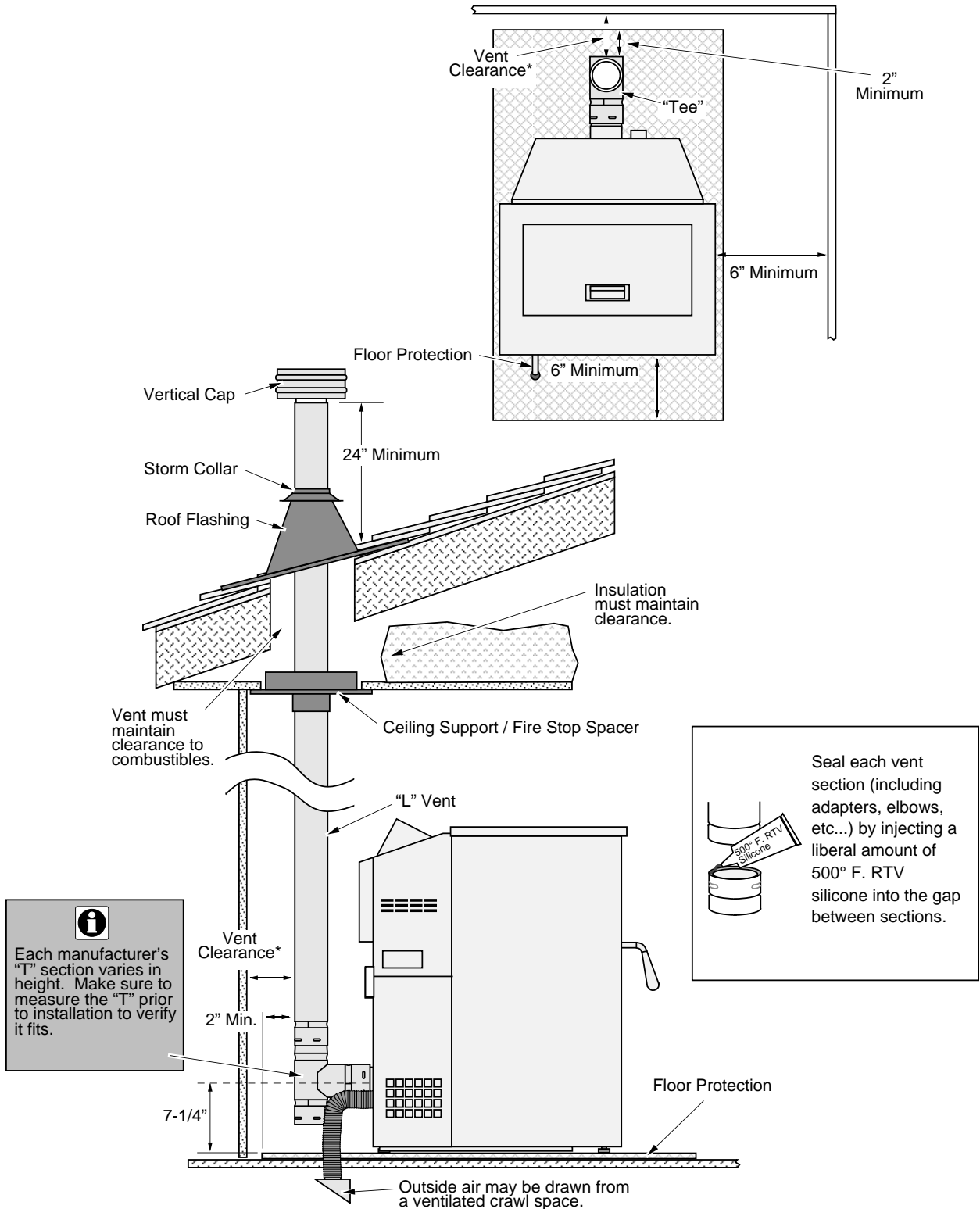



## Installation Example: Class "A" Chimney Retrofit

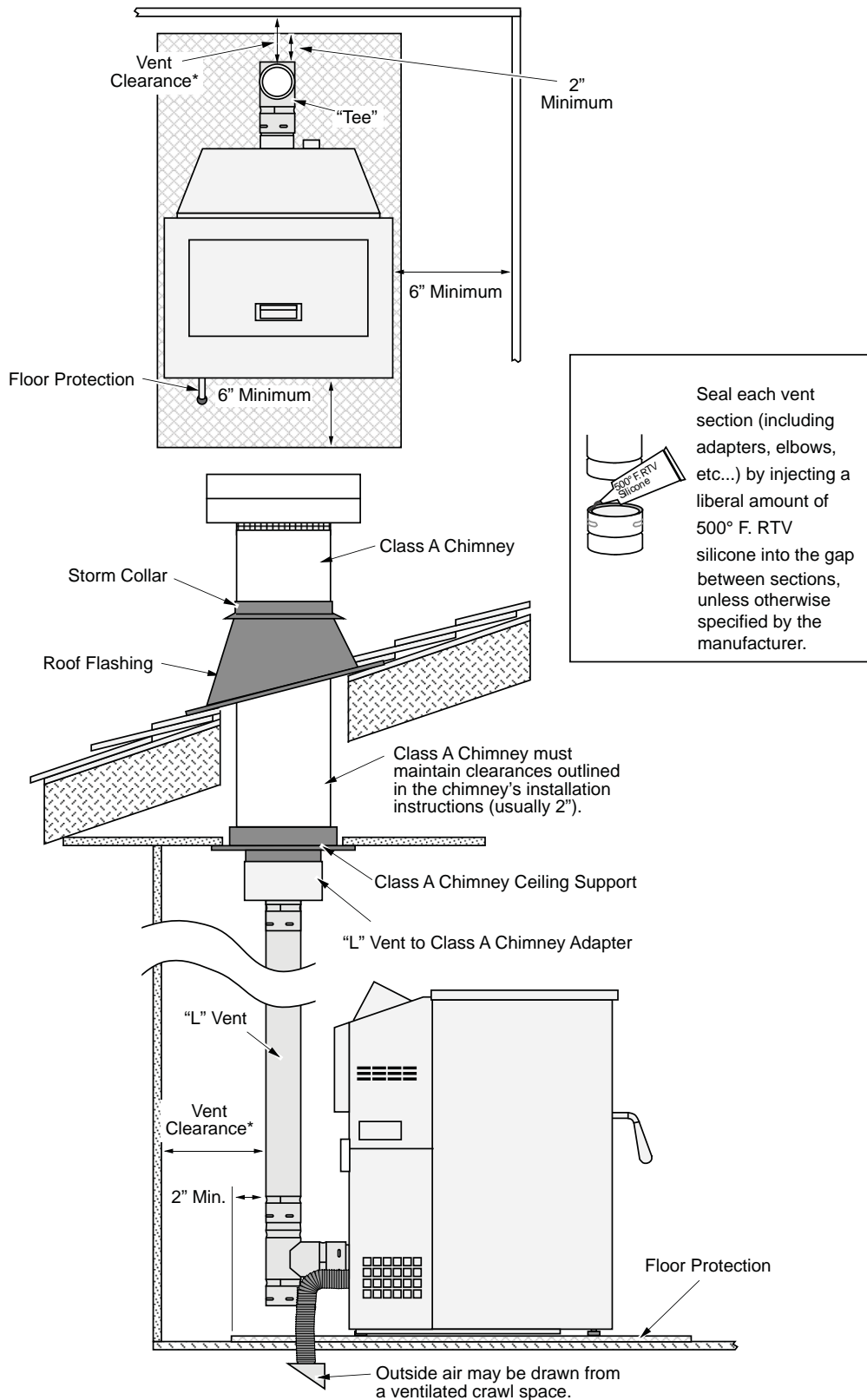

\* Install vent at clearance specified by the vent manufacturer.

## Installation Example: Masonry Fireplace Hearth Stove

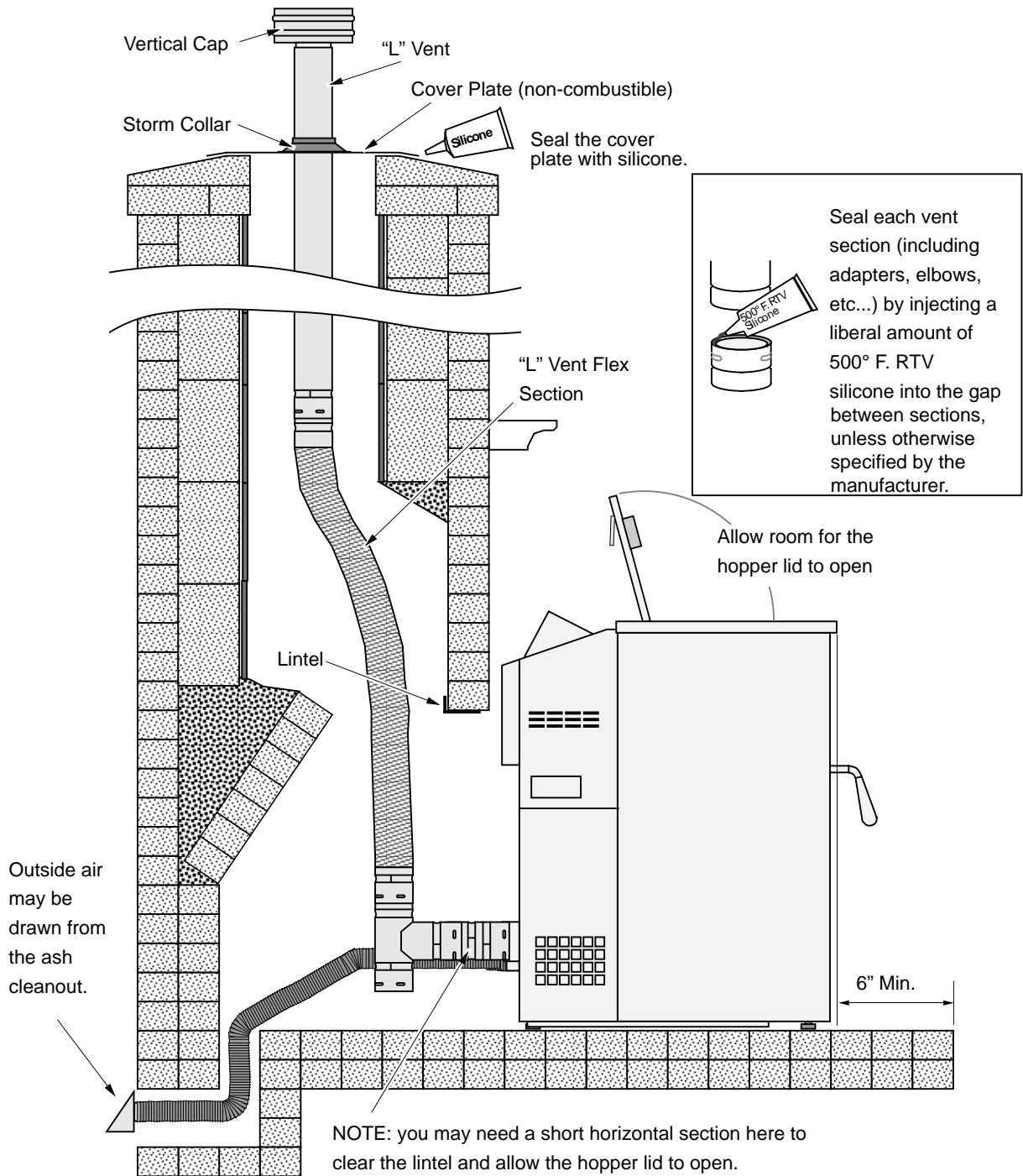

## Installation Example: Zero-Clearance (Metal) Fireplace Hearth Stove

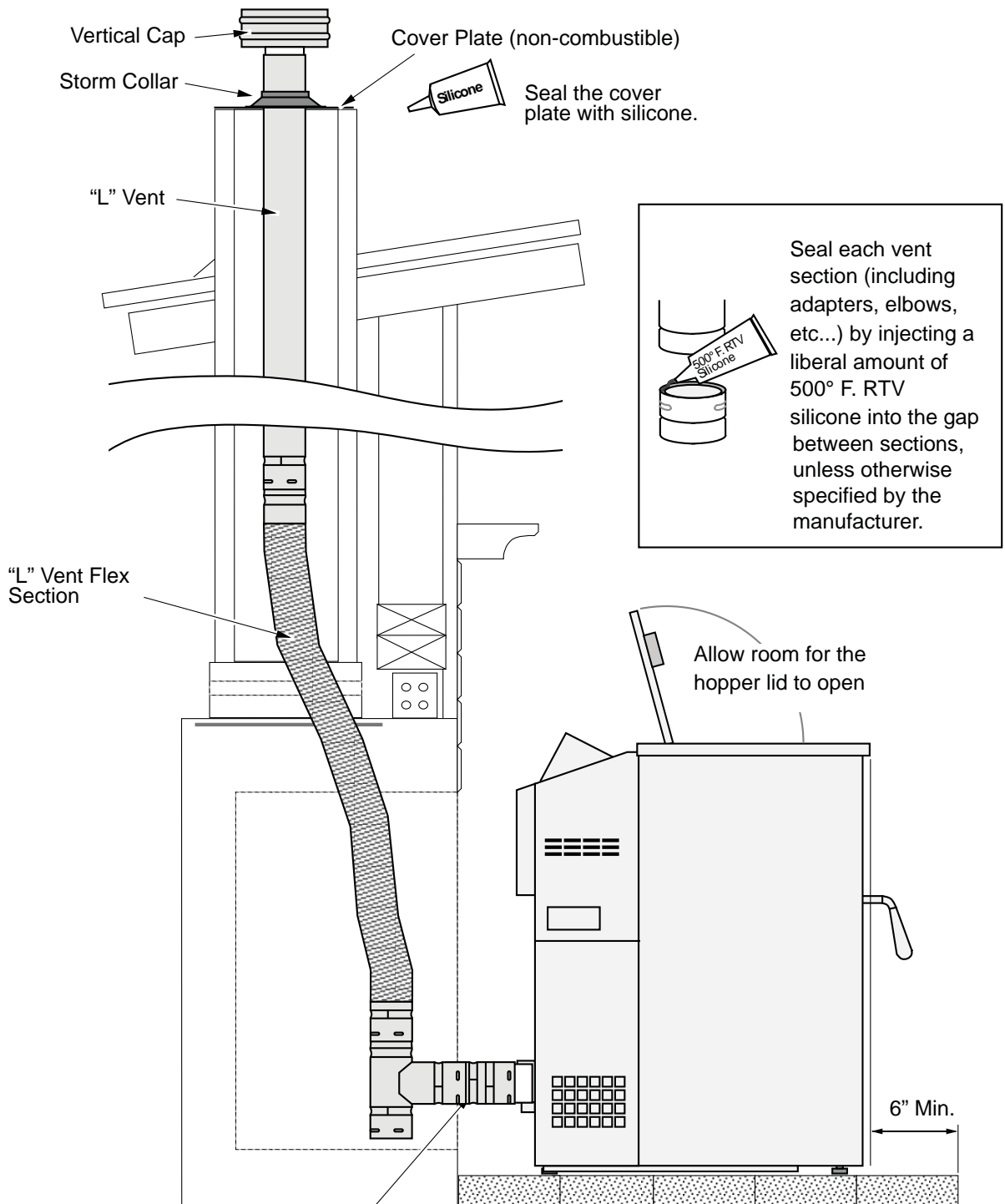

NOTE: you may need a short horizontal section here to clear the lintel and allow the hopper lid to open.

## Installation Example: Freestanding Masonry Chimney

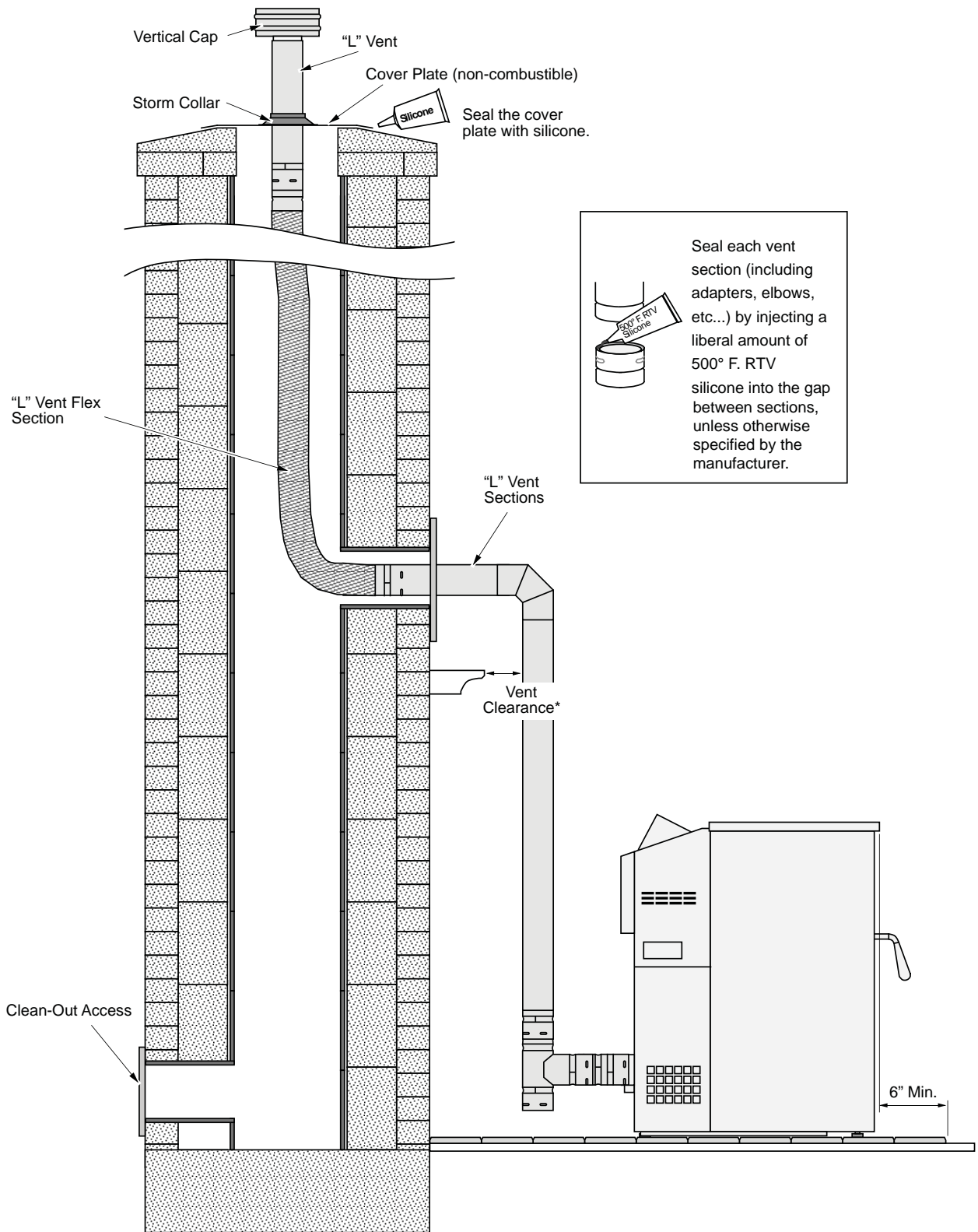

Seal each vent section (including adapters, elbows, etc...) by injecting a liberal amount of 500° F. RTV silicone into the gap between sections, unless otherwise specified by the manufacturer.

\* Install vent at clearance specified by the vent manufacturer.

## Safety Notice

READ THIS ENTIRE MANUAL (ESPECIALLY THE "SAFETY PRECAUTIONS" ON PAGES 4 AND 5) BEFORE USING THIS STOVE. FAILURE TO FOLLOW THE INSTRUCTIONS MAY RESULT IN PROPERTY DAMAGE, BODILY INJURY, OR EVEN DEATH.



DO NOT UNPLUG THE STOVE TO TURN IT OFF. THIS STOVE RELIES UPON ELECTRICITY TO PUSH THE FLUE GASES OUT THE PELLET VENT – UNPLUGGING IT MAY LEAD TO SMOKE ENTERING YOUR ROOM.



FAILURE TO MAINTAIN YOUR HEATER WILL LEAD TO A RESTRICTED COMBUSTION AIR SYSTEM, LEADING TO POOR PERFORMANCE AND IN SOME CASES, SMOKE SPILLAGE INTO THE ROOM. SEE THE "MAINTENANCE" SECTION FOR DETAILS.



DO NOT USE CHEMICALS OR FLAMMABLE FLUIDS TO START THIS HEATER.

## Location of Controls

The control panel is located at the top back of the stove as shown below. Open the control panel door to access the controls.

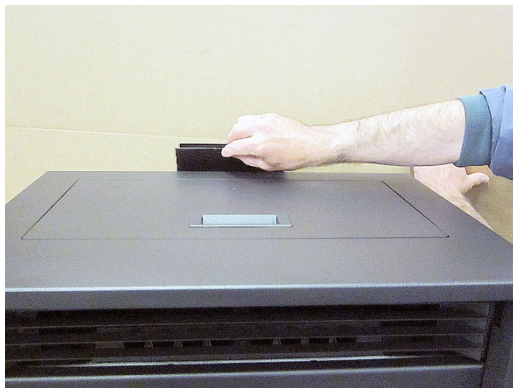

**IMPORTANT:** Do not let the control panel door bang open, it may scratch if it hits the stove top surface.

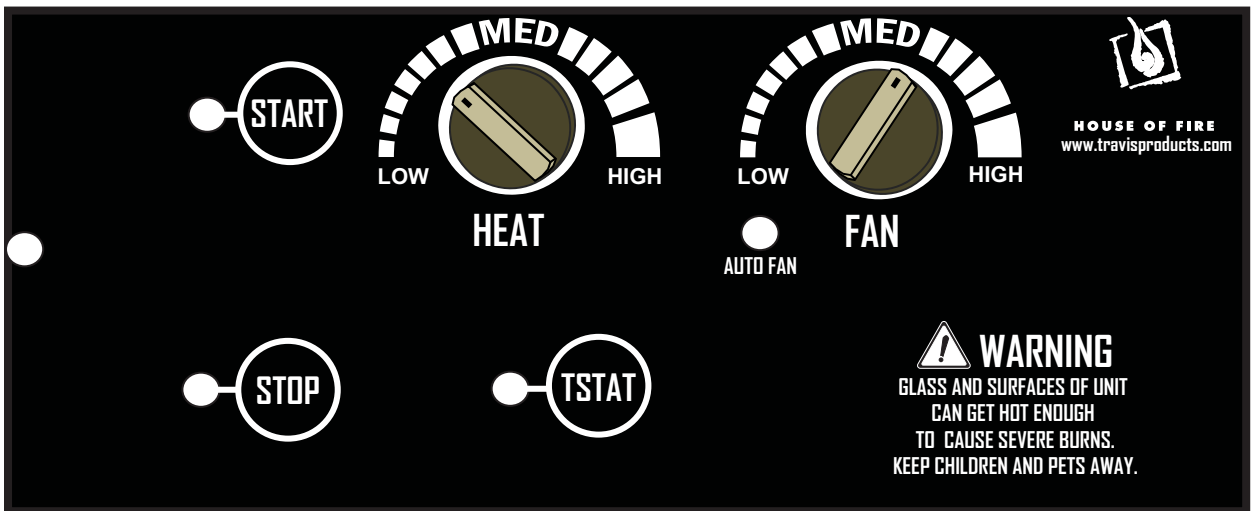

## Loading Pellets

Lift the hopper lid to its vertical position. Pour pellets into the hopper until full.

**NOTE:** The control panel door should be closed when opening the hopper lid, to prevent the two parts from making contact.

**HINT:** We recommend pressing the “STOP” button, then press the “START” button after reloading the stove.

**NOTE:** The stove will not run if the lid is open.



## Starting the Heater for the First Time

**Start the Heater - Let it Burn for 1 Hour - THEN OPEN THE DOOR.**

The stove paint is cured through heat. To prevent it from bonding to the door gasket, you must burn the heater for approximately 1 hour, then open and close the door to break any bonding.

### Curing the Paint

This stove uses a heat-activated paint that will emit some fumes while starting the first fire. Open doors and windows to the room to vent these fumes. You may also notice oil burning off of the interior of the stove. This rust-stopping agent will soon dissipate. Allow 48 hours for the paint to cure.

Allow 48 hours

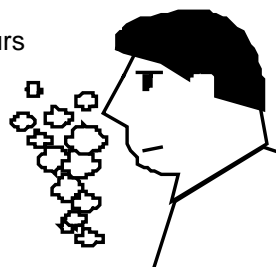
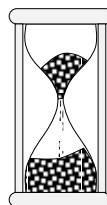

## Manual Mode

Manual mode requires the user to turn the heater on and off manually and select the heat output setting.

### To Start

Press the START button on the control panel. The stove will enter the start-up sequence for approximately 22 minutes.

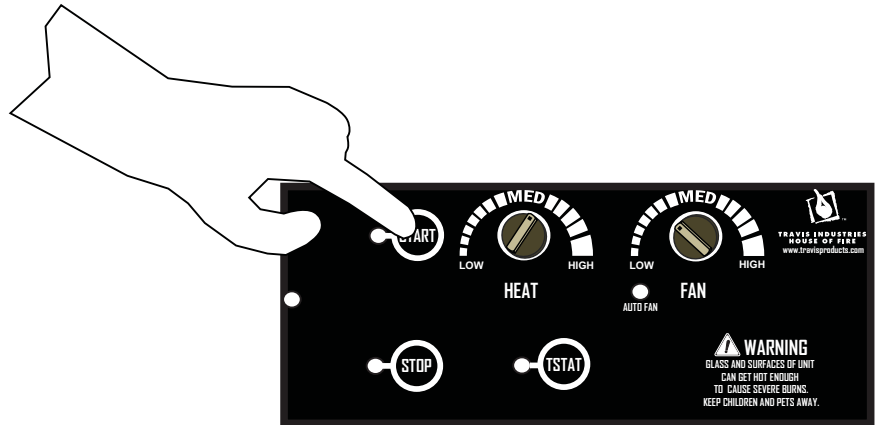

### To Shut Down

Press the STOP button on the control panel. The stove will begin the shut-down process, which takes approximately 45 minutes.

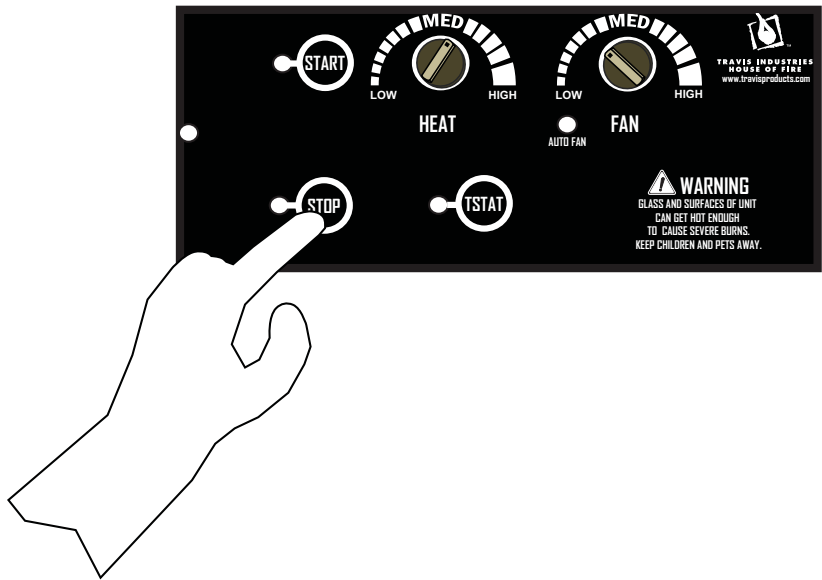

### To Adjust the Heat

Turn the HEAT knob on the control panel to the left (lower heat) or right (higher heat). The HEAT knob adjusts the rate of pellets feeding into the stove.

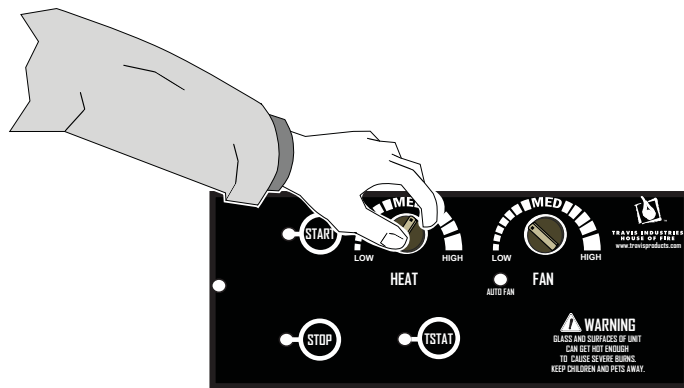

### To Adjust Heat Output

Turn the FAN knob on the control panel to the left (lower fan) or right (higher fan). The FAN knob adjusts the speed of the stove's blower to move more heat out into the room.

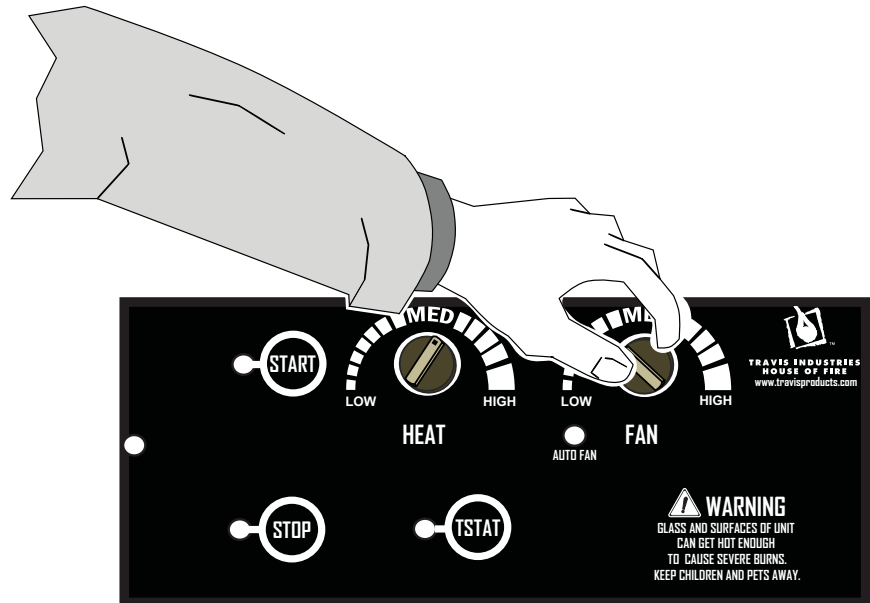

### Auto-Fan

Turn the FAN knob to the AUTO-FAN setting on the control panel to automatically adjust the fan speed based on the feed rate into the hopper. This allows for more efficient operation.

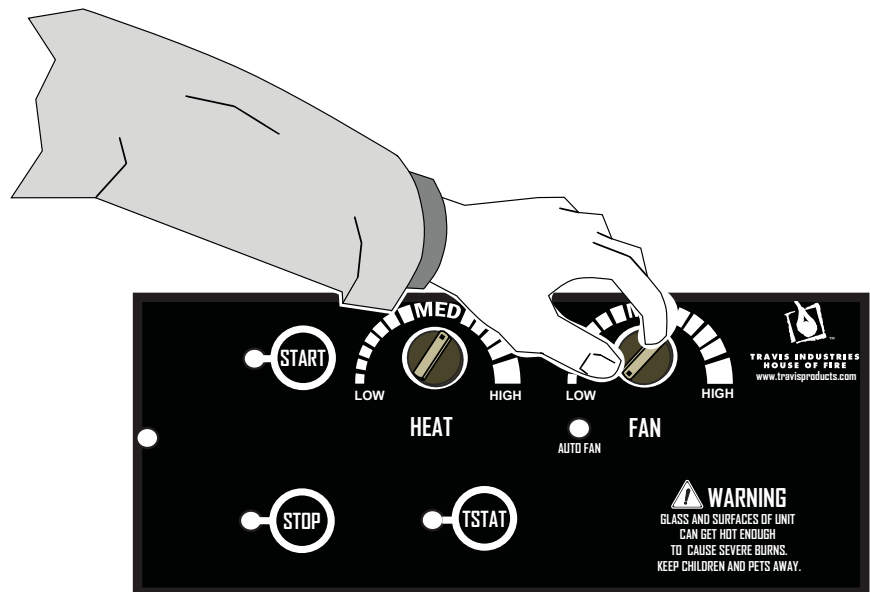



## TSTAT (Thermostat) Mode

TSTAT mode allows you to use a thermostat to control room temperature. The stove automatically turns on when the temperature drops below the thermostat setting and turns off (or to low) once the thermostat setting is met.

Wireless thermostats are available from Travis Industries. See your dealer for details.

### To Start the Stove in TSTAT Mode

Press the TSTAT button on the control panel. If there is a call for heat from the thermostat, the stove will enter the start-up sequence for approximately 22 minutes.

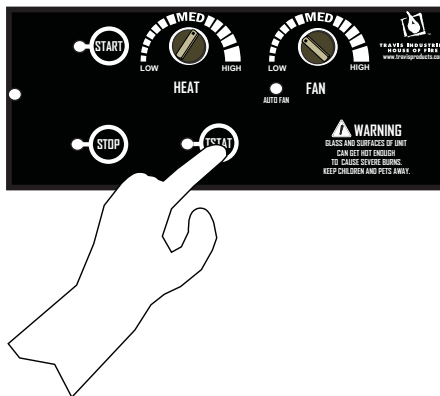

### To Adjust the Heat Output

Use the HEAT knob on the control panel to adjust the heat output.

#### **NOTE:**

Depending upon which TSTAT Program you are in (1, 2, or 3), the heat output may vary once the target temperature is reached. For details see "Changing the TSTAT Program" on the following page.

#### **TIP:**

If you find that the stove turns on and off repeatedly, you may wish to turn the heat output to a lower setting, which will provide a more consistent heat output over time, and eliminate the need for the thermostat to repeatedly turn the stove off.

### To Shut Down

Press the STOP button on the control panel. The stove will begin the shut-down process, which takes about approximately 45 minutes.

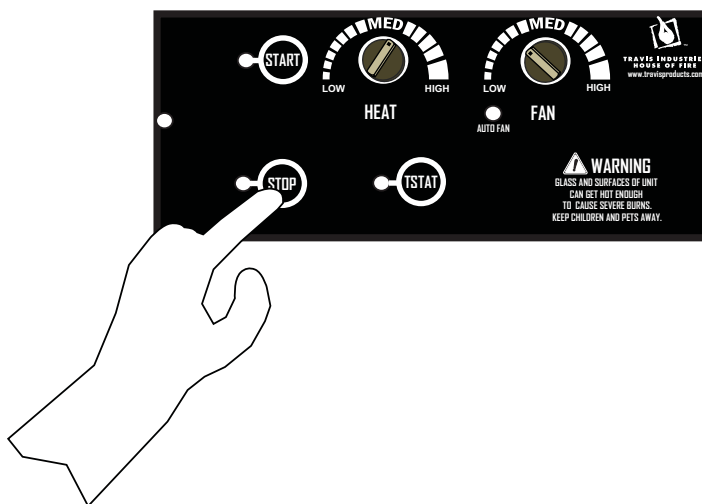

## Changing the TSTAT Program

This heater comes with three TSTAT programs built in. Each program is unique and allows you to modify your thermostat setting to your preference. The stove is shipped pre-programmed in TSTAT program 1.

### How to Tell Which TSTAT Program You Are In

When you press the “STOP” and “TSTAT” button simultaneously while the unit is cold the blue Auto-Fan LED light will flash. It will flash once for Program 1, twice for Program 2, and three times for Program 3.

### Switching Between Program 1, 2, and 3

Each time you press the “STOP” and “TSTAT” button simultaneously while the unit is cold, the TSTAT program will toggle to the next program. Continue to press these two buttons until the blue Auto-Fan LED light flashes the program you wish to use.

### Thermostat Program 1

When the thermostat stops calling for heat (the thermostat is open) the thermostat “steps down” to a lower heat setting. The heater will stay at this setting for 15 minutes. If the thermostat does not call for heat, the thermostat will “step down” again to a lower setting (or off). At any time if the thermostat calls for heat (thermostat is closed) during this cycle, the heater will resume at the HEAT output setting set at the control board.

Heater Set at <b><u>HIGH</u></b>	If thermostat calls for heat ( <u>thermostat closed</u> ) Heater runs at setting set on control panel dial.	If thermostat stops calling for heat ( <u>thermostat open</u> ) Heater goes to MEDIUM. If after 15 minutes thermostat still open, heater goes to MEDIUM-LOW. If after 15 minutes thermostat still open, heater goes to LOW. If after 15 minutes thermostat still open, heater turns off.
Heater Set at <b><u>MEDIUM</u></b>	If thermostat calls for heat ( <u>thermostat closed</u> ) Heater runs at setting set on control panel dial.	If thermostat stops calling for heat ( <u>thermostat open</u> ) Heater goes to MEDIUM-LOW. If after 15 minutes thermostat still open, heater goes to LOW. If after 15 minutes thermostat still open, heater turns off.
Heater Set at <b><u>MEDIUM-LOW</u></b>	If thermostat calls for heat ( <u>thermostat closed</u> ) Heater runs at setting set on control panel dial.	If thermostat stops calling for heat ( <u>thermostat open</u> ) Heater goes to LOW. If after 15 minutes thermostat still open, heater turns off.
Heater Set at <b><u>LOW</u></b>	If thermostat calls for heat ( <u>thermostat closed</u> ) Heater runs at setting set on control panel dial.	If thermostat stops calling for heat ( <u>thermostat open</u> ) Heater will run for 15 minutes. If thermostat still open, heater turns off.

**NOTE:** This program is not recommended for areas with little heating requirements (mild climates, small rooms, etc.).

### Thermostat Program 2

In Thermostat Mode Program 2 when the thermostat stops calling for heat (the thermostat is open) the following happens:

- The burn rate decreases to Level 1 (low) for 15 minutes. If there is no call for heat during that time...
- The unit turns off.

If there is a call for heat by the thermostat (the thermostat is closed) at any point during this cool-down period then the burn rate resumes corresponding with the setting on the control panel.

### Thermostat Program 3

In Thermostat Mode Program 3 when the thermostat stops calling for heat (the thermostat is open) the following happens:

- The burn rate decreases to Level 1 (low) and remains at this level until there is a call for heat by the thermostat (the thermostat is closed), then resumes corresponding with the setting on the control panel.

## ***Start-Up Sequence (Igniter)***

---

The stove enters a start-up sequence whenever there is a call for heat and the unit isn't in Run mode. This ensures proper operation through all possible settings and operational states (hot or cold, pellets burning or not burning, etc.), and overrides all user settings (except the OFF position). During this period the START light will flash. The stove will not enter start-up if you are loading pellets into the hopper.

During the start-up sequence, the pellets will load into the fire platform, the flame will ignite, and the room air blower will come on when the heater comes up to the selected temperature.

**NOTE:** If the heater doesn't light 2 times in a row, both the START and STOP lights will turn on. The combustion blower will run for about an hour before shutting off. Check to make sure there are pellets in the hopper. We recommend cleaning the burn pot and making sure all air ports are clear of debris. Reset the unit by unplugging it and then plugging it back in.

## ***Power Outages***

---



**Because this stove relies upon a blower to evacuate smoke, some smoke may enter the home during a power outage. Leave the door closed to keep the possibility of smoke spillage to a minimum.**

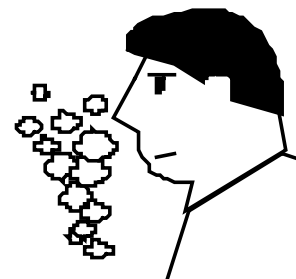
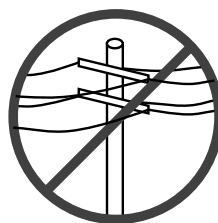

**NOTE:** Travis Industries recommends a minimum vertical vent of 5' to ensure adequate draft during a power outage.

**NOTE:** The exhaust blower will start and run up to 20 minutes every time power is interrupted (or the power cord is unplugged and plugged in). The red light on the control panel will also turn on. This safety feature evacuates smoke from the heater after a power interruption.

### **Manual Mode**

If a power outage occurs when the unit is hot, it will enter the start-up sequence. If the unit has cooled it will enter a cool-down phase (exhaust blower will run up to 20 minutes to ensure smoke evacuation).

### **TSTAT Mode**

If a power outage occurs while in TSTAT mode, the unit will continue to operate. If the thermostat calls for heat, the unit will enter the start-up sequence and restart. If the thermostat does not call for heat it will enter a cool-down phase (exhaust blower will run up to 20 minutes to ensure smoke evacuation).

## Stove Maintenance

The following section details extensive maintenance procedures. We strongly suggest these items be carried out by a trained service technician, possibly by a service agreement set up with your dealer.

**NOTE:** Pellet quality can vary by state and the maintenance schedule may need to be revised to maintain the heater's effectiveness.



**DISCONNECT THE POWER CORD AND MAKE SURE THE HEATER HAS FULLY COOLED (APPROXIMATELY 45 MINUTES) PRIOR TO CONDUCTING SERVICE.**

### Maintenance Schedule

Weekly Maintenance (or every 5 bags of fuel):

- Inspect Burn
- Clean the fire platform
- Clean the heat exchange tubes

Monthly Maintenance (or every 20 bags of fuel):

- Empty the ashpan
- Clean vertical exhaust ducts
- Clean the glass

Yearly Maintenance (or every ton of fuel):

- Clean firebox liners
- Clean lower exhaust duct
- Clean convection blower
- Clean negative pressure tube
- Clean the vent
- Clean under fire platform
- Adjust door hinge and latch
- Check for air leaks

### Removing Flyash

This heater was designed to allow for easy flyash removal with the included tools. However, to ease maintenance, several pellet stove owners have purchased vacuums specifically made to remove flyash. Furthermore, some of these vacuums are heat-resistant to allow for flyash removal while it is still warm. **DO NOT USE A STANDARD VACUUM ON THIS APPLIANCE** (except to clean the pellet dust out of the hopper). Standard vacuums may spread the fine particles inside the flyash into the home and are not heat-resistant (hot flyash may cause the internal portion of vacuums to ignite).

**NOTE:** Ask your authorized Travis dealer for a recommended ash vacuum.

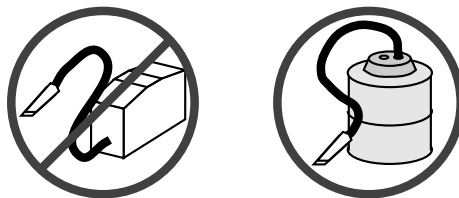

### Disposal of Ashes

Ashes should be placed in a metal container with a tight-fitting lid. The closed container of ashes should be placed on a noncombustible floor or on the ground, well away from all combustible materials, pending final disposal. If the ashes are disposed of by burial in soil or otherwise locally dispersed, they should be retained in the closed container until all cinders have been thoroughly cooled.

## Stove Maintenance Tools

Included with the stove are three tools for maintenance: a bottle brush, brush and the cleaning tool.



## Stove Tool Storage

The stove tools may be stored on the hooks on the back of the stove. To use the hooks for the first time, bend the hooks with a screwdriver or needle-nose pliers, then hang the tools on the hooks as shown below.



## Opening the Door



**MAKE SURE THE HEATER HAS FULLY COOLED (APPROXIMATELY 45 MINUTES) BEFORE OPENING THE DOOR AND CONDUCTING SERVICE.**

Turn the handle clockwise and pull to open the door, as shown below.



## Weekly Maintenance (or Every 5 Bags of Pellets) - Inspect the Burn

Once a week you should inspect the flame quality inside your appliance. When burning on high, the flames should be bright orange. If the flames seem to be coming only from the sides, or are orange/black, turn the heater off and check for clinkers (ashes that solidify into a clump). The most likely causes of clinkers are:

- Restrictor needs adjustment (see "Restrictor Adjustment" in the Installation section of this manual)  
**NOTE:** The optimum restrictor position will vary over time as soot builds up inside the exhaust system. See "Restrictor Adjustment" for details.
- Poor pellet quality
- The door or glass has an air leak
- The exhaust system requires cleaning

## Weekly Maintenance (or Every 5 Bags of Pellets) - Clean the Fire Platform

Once a week you should clean and inspect the fire platform. The following steps outline this process.

1. Open the door.
2. Remove the visual deflector. Note how the cover has a mounting hole on the left side and hooks on the right that fit over the pins inside the firebox.

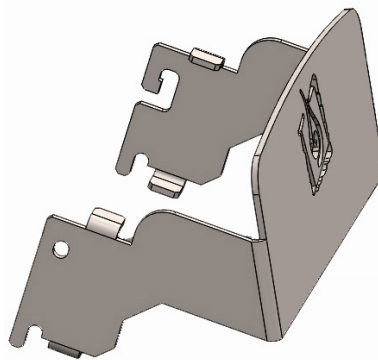

a) Lift the right side of the visual deflector up and pull it forward.



b) Slide the the visual deflector to the left while lifting from the right. Once the pin disengages from the visual deflector on the left side, the visual deflector may be removed from the firebox.



### NOTES ON REPLACING THE VISUAL DEFLECTOR

When replacing the visual deflector, follow steps “a” and “b” in reverse order (see previous page). After you have repeated this process a couple times, it will become easier. When in place, make sure the visual deflector is pressed down fully on the right side. The visual deflector holds the burn platform in place and keeps it properly aligned during operation. If it is not fully seated, airflow to the burn platform may be displaced and the appliance m burn poorly.

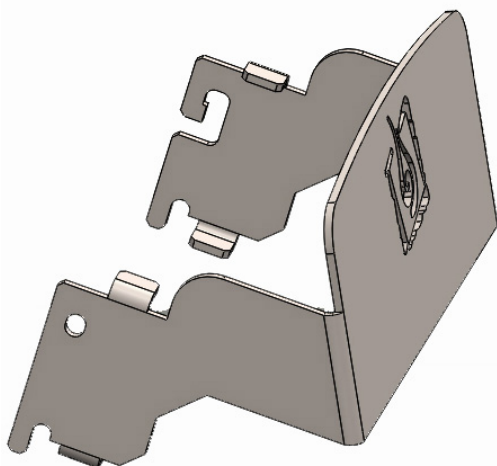



3. Use the cleaning tool to scrape away hardened clinkers or buildup on the fire platform. Use the narrow tip to clear any plugged holes. The fire platform must be free from buildup for the pellets to burn completely.



4. Brush away flyash around the fire platform using the brush included with the insert. The flyash will fall into the ashpan below.

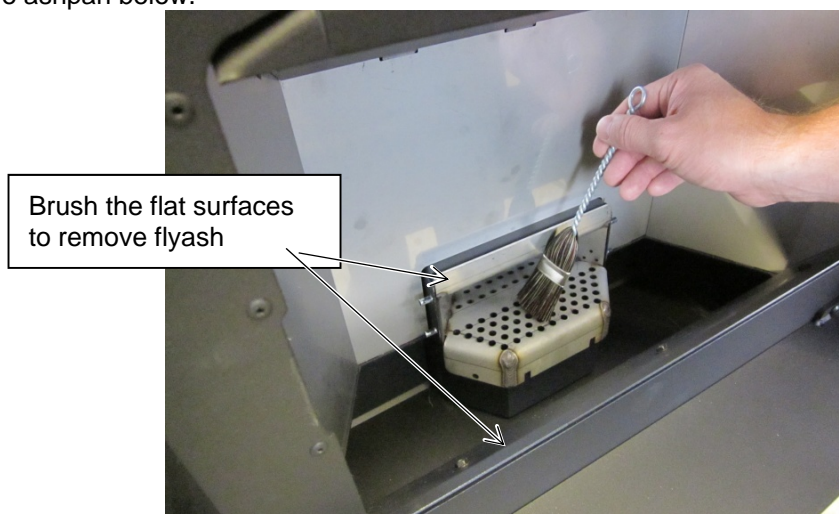

5. Lift the fire platform out of the firebox and remove any flyash below the burn platform.





## Weekly Maintenance (or Every 5 Bags of Pellets) - Clean the Heat Exchange Tubes

The heat exchange tubes may accumulate ash when the appliance is in use. To clean, follow the directions below.

1. With the door closed, pull the stove grill up and forward as shown below.

**NOTE:** Use both hands on the grill. Using one hand in the middle of the grill may cause it to warp.



2. Hook the cleaning tool onto the heat exchange scraper rod as shown below.



3. Move the scraper rod back and forth a few times to clean the heat exchange tubes.

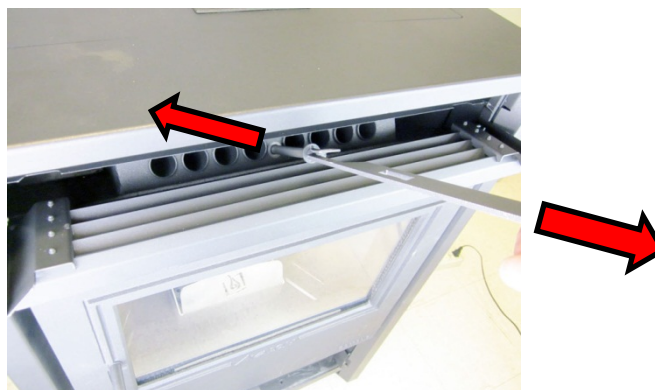

### Cleaning Behind the Firebox Liners

Front View of Firebox Liners

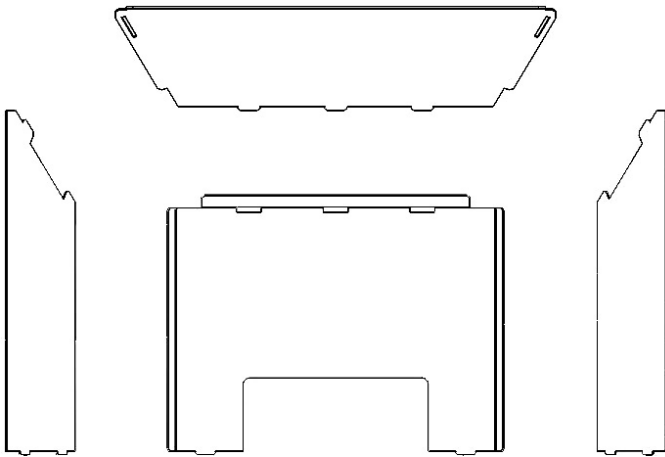

Isometric View

(note how the top liner has a flange that bends down)

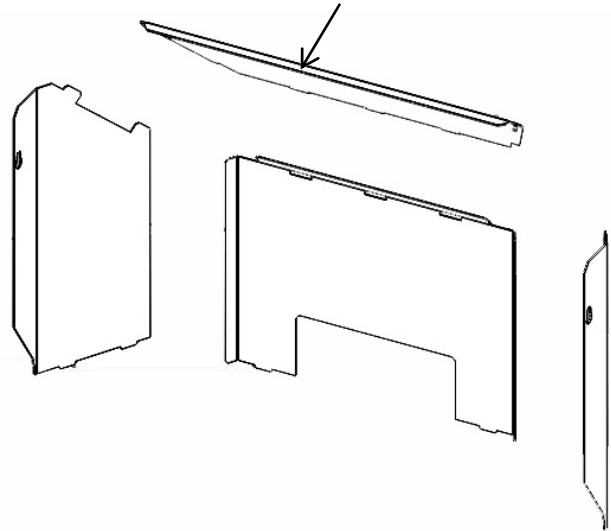

The firebox liners help trap flyash before it enters the exhaust blower. Remove the liners and clean the area behind them following the directions below.

1. Open the door.
2. Remove the top liner. It is held in place with 3 tabs at the bottom and one large tab (and slot) on the sides. To remove, lift it up and slide it out.

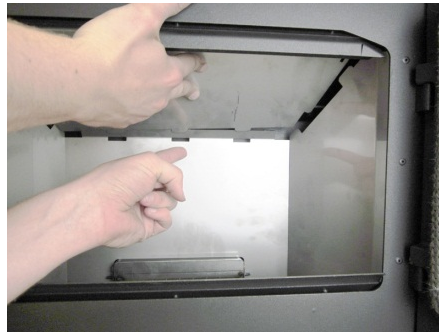

3. Remove the side liners. They have keyhole slots that fit over screws on the side of the firebox. Lift them up, tilt them inwards, then remove.

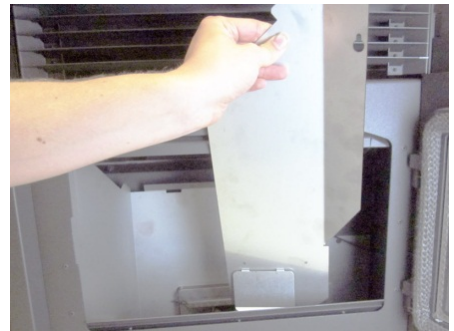

4. Remove the rear liner. Lift it up and remove it from the firebox.



5. With the liners removed, clean all flyash and debris from the firebox. Clean the liners before replacing.



## Monthly Maintenance (or Every 20 Bags of Pellets) - Clean the Glass

Open the doors and clean the glass with a non-abrasive glass cleaner and rag.



### Monthly Maintenance (or Every 20 Bags of Pellets) – Empty the Ashpan



**MAKE SURE THE HEATER HAS FULLY COOLED (APPROXIMATELY 45 MINUTES) BEFORE CONDUCTING SERVICE.**



**THE ASHPAN MUST BE IN PLACE WHILE THE HEATER IS IN USE.**

The ashpan will accumulate ash as you use the appliance. See the steps below to empty the ashpan.

1. Rotate the ashpan handle clockwise and pull it down to access the ashpan.



2. Slide the ashpan forward. Use the built-in rod to lift the ashpan out of the firebox.

**NOTE:** Do not use the ashpan handle to pull the ashpan out; instead use the lip on the front of the ashpan.

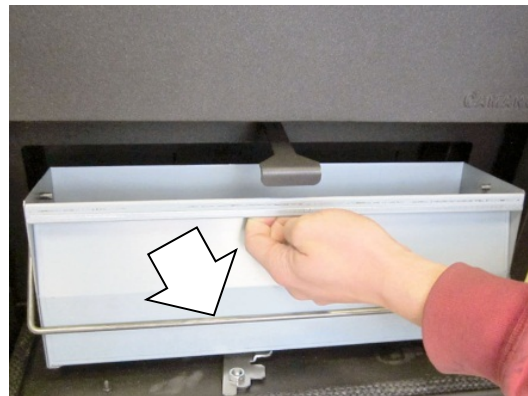

3. Remove the ashpan from the appliance and properly dispose of the ashes (see “Disposal of Ashes” on page 28 for details).

## Yearly Maintenance (or Every Ton of Pellets) - Clean the Lower Exhaust Duct

1. With the ashpan removed (see page 36), remove the ashpan guide as shown below. Clean the area under the ashpan guide.

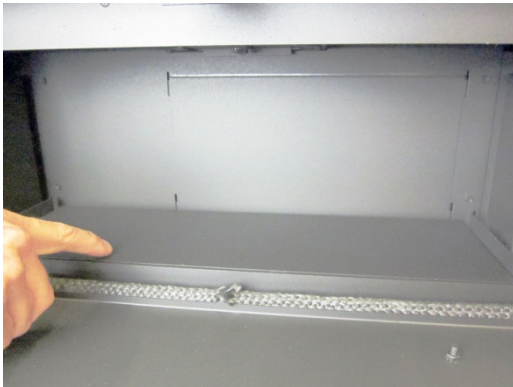

2. Remove the exhaust duct cover as shown below. Press up on it and lift it out.



3. Remove the exhaust channel cover plate and gasket (11/32" nutdriver).

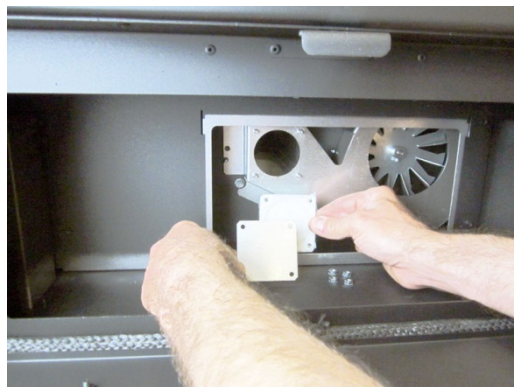
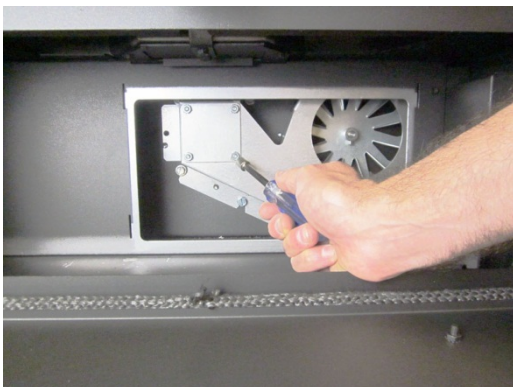

4. Clean the exhaust channel with the bottle brush or vacuum.

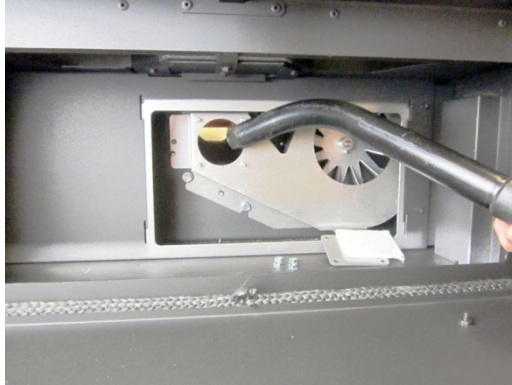

5. Clean the combustion blower with the bottle brush or vacuum.

**NOTE: Take care to prevent damaging the combustion blower impellers.**





## Yearly Maintenance (or Every Ton of Pellets) - Clean the Convection Blower

1. Remove the thumb screw on the left side of the stove. Swing the panel out, slide it forward to remove, and place it aside.



2. Remove the top and bottom screws securing the convection blower cover and remove the cover as shown below (5/16" nutdriver).

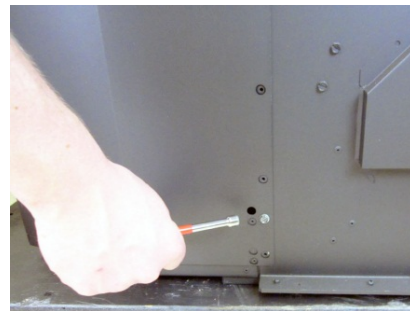

3. Remove the 2 nuts securing the blower using a 7/16" nutdriver. Lift out and remove the convection blower from the stove as shown below.

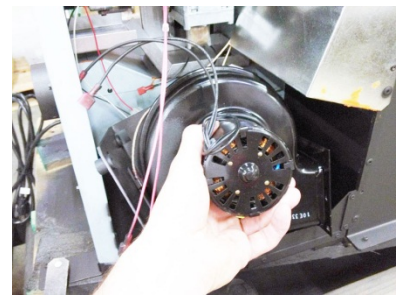
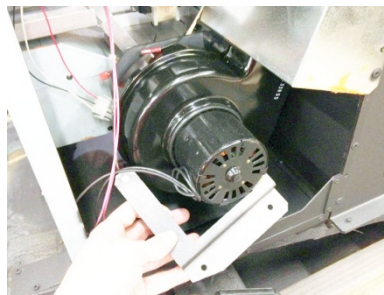
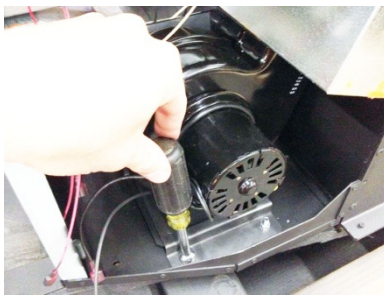

4. Remove all dust and debris from the convection blower.

**NOTE: Take care to prevent damaging the combustion blower impellers.**



### Yearly Maintenance (or Every Ton of Pellets) - Clean the Negative Pressure Tube

1. Disconnect the end of the tube from the combustion blower.

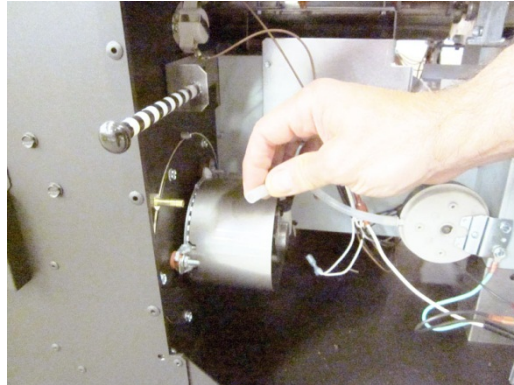
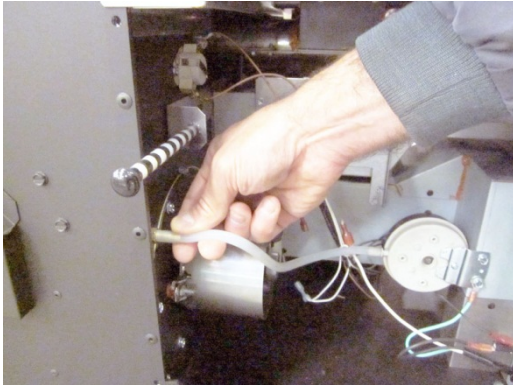

2. Clean the nozzle using a pipe cleaner.

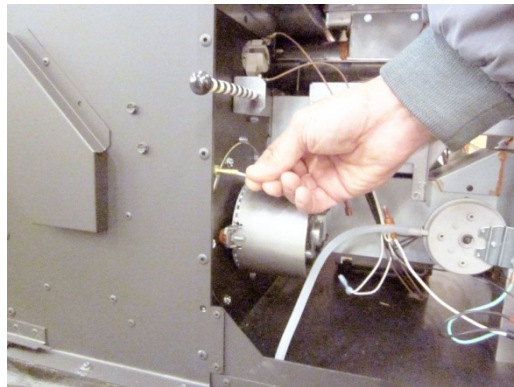
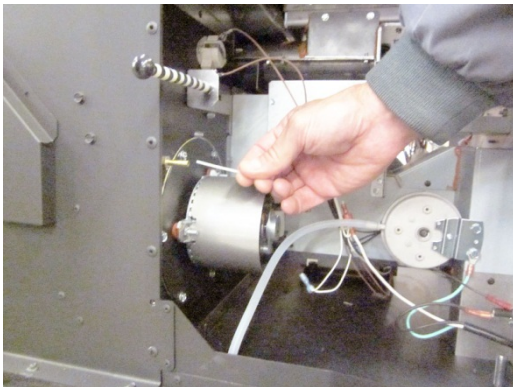

### Yearly Maintenance (or Every Ton of Pellets) - Clean the Vent

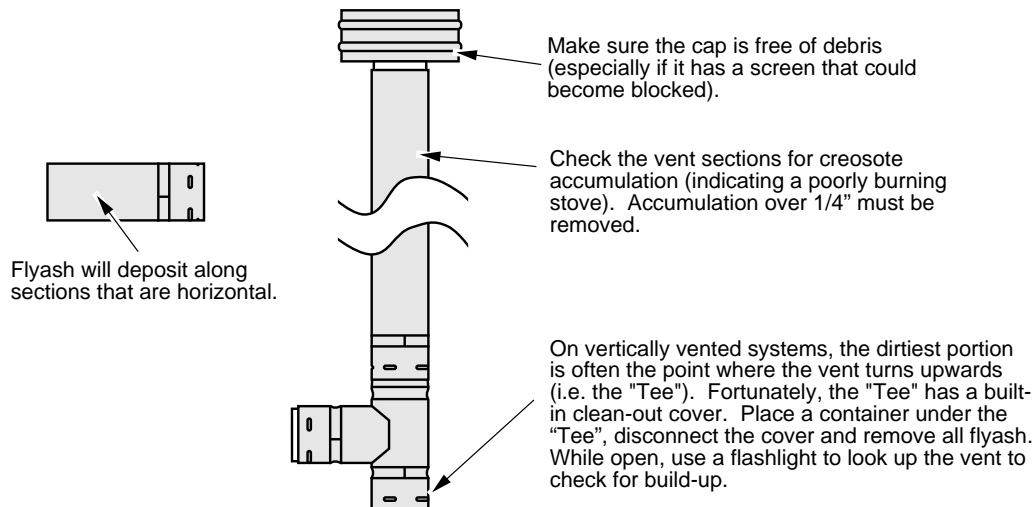

**WHENEVER ANY PORTION OF THE PELLET VENT IS DISCONNECTED, THE JOINTS MUST BE SEALED WITH RTV 500° F. SILICONE SEALANT, UNLESS OTHERWISE SPECIFIED BY THE VENT MANUFACTURER.**



## Yearly Maintenance (or Every Ton of Pellets) - Adjust the Door Cam

The door cam should be tight enough to pull the door against the face of the stove yet not so tight as to not allow full handle rotation. To tighten the door cam, remove the door handle and remove one of the washers between the door frame and cam (the washer may be stored for future use by placing it between the cam and nut). To loosen the door cam, add a washer between the door frame and cam.

**NOTE:** Older models use 7 washers between the door & cam. Newer models use 1 bushing & 3 washers.

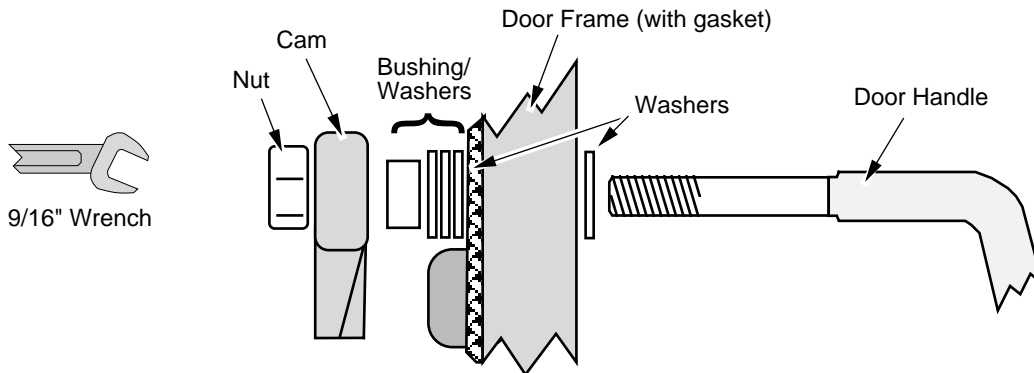

## Yearly Maintenance (or Every Ton of Pellets) - Check for Air Leaks Around the Door, Glass, and Ashpan



**Air leaks into the firebox will decrease the stove's performance greatly, leading to excessive sooting, inefficient burning, and perhaps a malfunction.**

- Inspect the door gasket to make sure it is fully attached. Use stove gasket cement to re-attach if necessary. If the door gasket is worn or flattened, replace.
- If the glass is cracked, replace. The glass is held in place with clips.
- Open the ashpan access door and inspect the gasket around the door. Re-attach or replace the gasket if necessary. Re-attach, or replace the gasket if necessary.

**NOTE:** Ask your authorized Travis dealer to demonstrate how to check a door seal.

## Troubleshooting Table

Lights on the control panel will flash when a fault has occurred. Follow the steps below to diagnose the problem before calling customer service.

### Diagnostic Codes

Diagnostic Code:	Possible Cause:	Don't Call for Service Until You:
Red "STOP" light flashes.	A failed combustion blower, pressure switch, or push auger can cause this error.	Press the START button again to try to ignite the stove.
The red "STOP" and green "START" light are on simultaneously	Two consecutive startup attempts have failed.	Check the pellet level in the hopper and verify there are pellets. Clean the burn pot.
Blue "AUTO FAN" light is flashing	One of the safety disks has tripped and the unit has entered a safety shutdown mode.	Hold the "STOP" button for 3 seconds Make sure the stove is clean and free of ash and debris, and that the room air blower functions and is clean.

**NOTE:** Always check to make sure pellets are in the hopper.

**NOTE:** Always check the fire platform for build-up and clean away any debris that may have accumulated.

## Replacement Parts

Contract your Travis Industries Dealer for replacement parts. Use only replacement parts from Travis Industries designed specifically for this heater.

### Door Parts

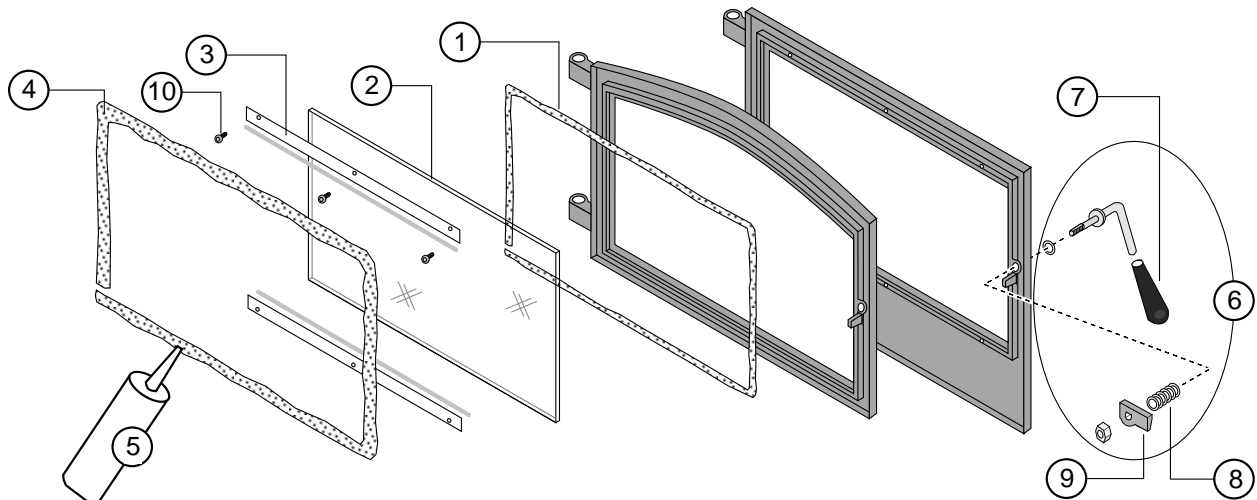

ID #	Description	Qty	Part #	ID #	Description	Qty	Part #
1	Glass Gasket (3/8" Diameter)	1	250-02801	2	Glass - Rectangular Glass - Arched	1 1	250-02073 250-02678
3	Glass Clips w Gasket	1	250-00174	4	Door Gasket (7/8" Diameter)	1	250-00178
5	RTV High Temp. 600° Silicone			6	Door Handle Assembly	1	250-02074
7	Door Knob	1	250-02964	8	Door Washer	1	250-00364
9	Door Cam	1	250-00598	10	Screws (8) 8-32 x 1/2" Torx	1	250-01478

## Wiring Diagram

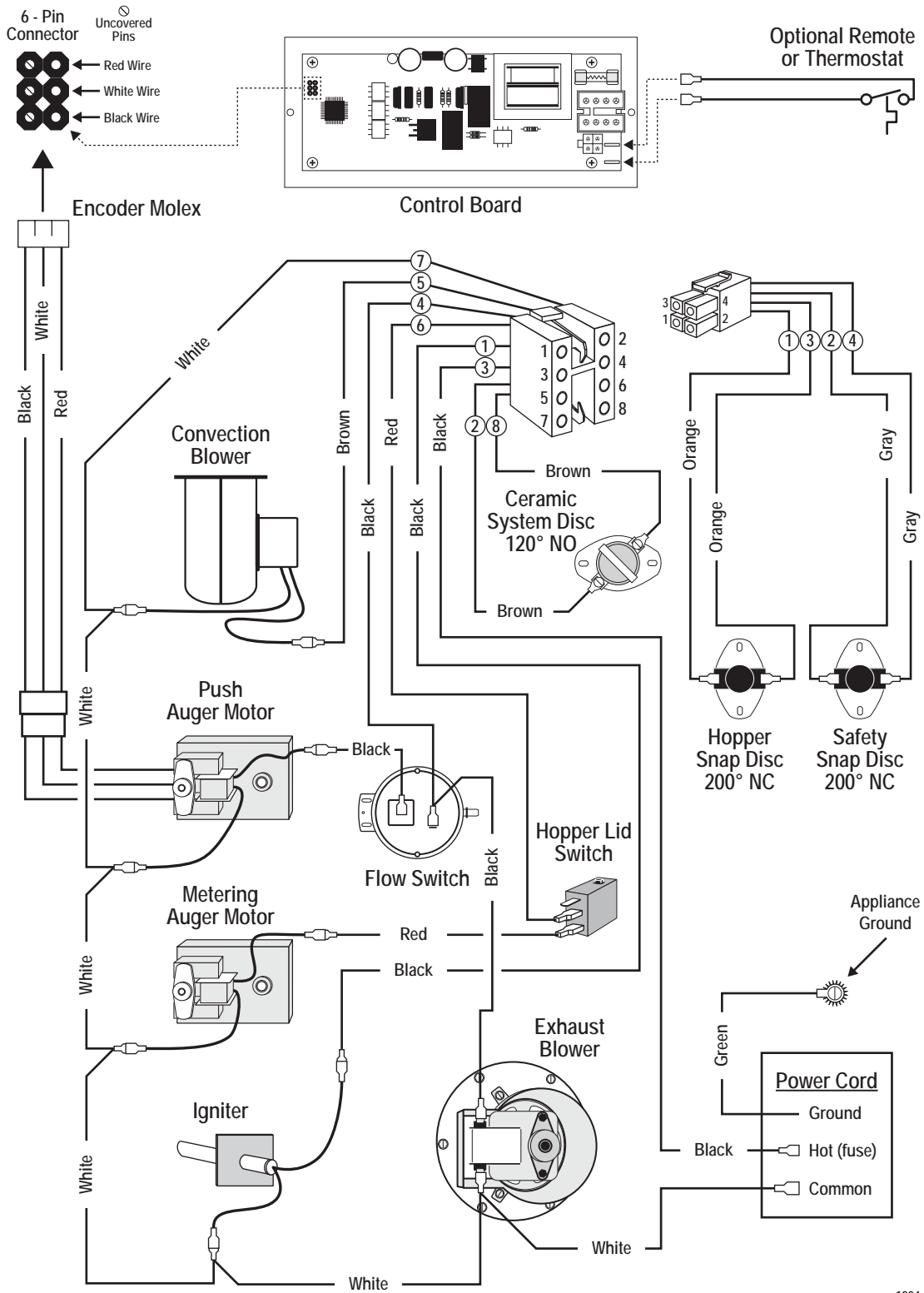

1004

## Wireless Thermostat Installation (Optional)



**DO NOT CONNECT 120 VAC OR 24V TO THE THERMOSTAT CIRCUIT OF THIS HEATER (DO NOT USE A HOUSEHOLD THERMOSTAT USED FOR A WALL-BOARD OR OTHER ELECTRICAL HEATER). USE A LOW VOLTAGE COMPATIBLE THERMOSTAT.**

Install the thermostat as follows:

### Left Side of Stove

1. Remove the thumb screw on the left side of the stove. Swing the panel out, slide it forward to remove, and place it aside.



2. Remove the two screws securing the access panel (5/16" nutdriver).



3. Open the access panel.

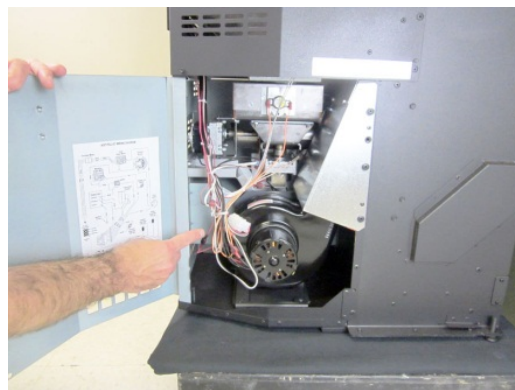

4. Route the wires labeled "TSTAT" under the auger motor to the right side of the stove.

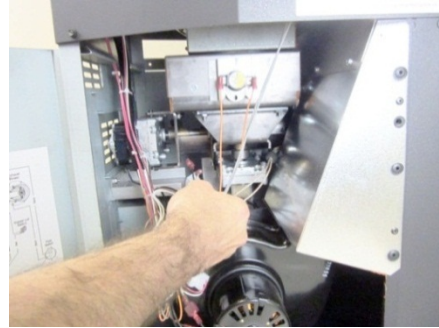
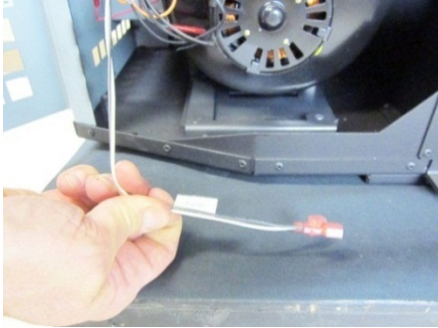

5. Replace and secure the left access side panel and cover.

## Right Side of Stove

6. Remove the knob from the air shutter rod.



7. Remove the thumb screw on the right side of the stove. Swing the panel out, slide it forward to remove, and place it aside.

NOTE: Take care not to damage or remove the black and white nylon spacers.



8. Remove the two screws securing the access panel (5/16" nutdriver).





9. Open the access panel.



10. Remove the cover plate and remote holder from the side of the unit (discard the cover plate) (1/4" nutdriver). Retain the screws.

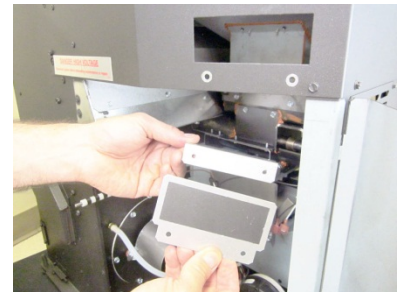
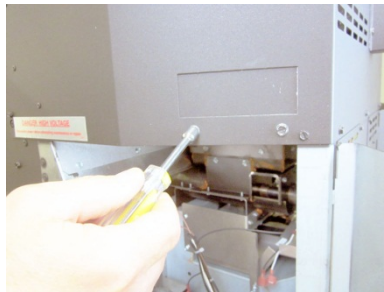
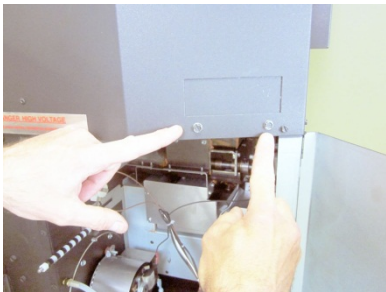

11. Attach the thermostat receiver to the remote holder with the four thread-cutting screws included with the remote.

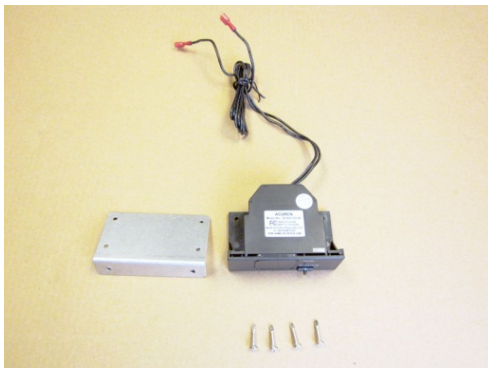

12. Install the receiver as shown below (use the screws removed in step 10).

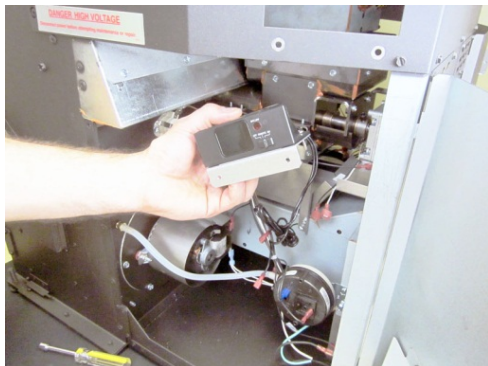

13. Connect the "TSTAT" wires from the main wire harness to the wires on the thermostat receiver.

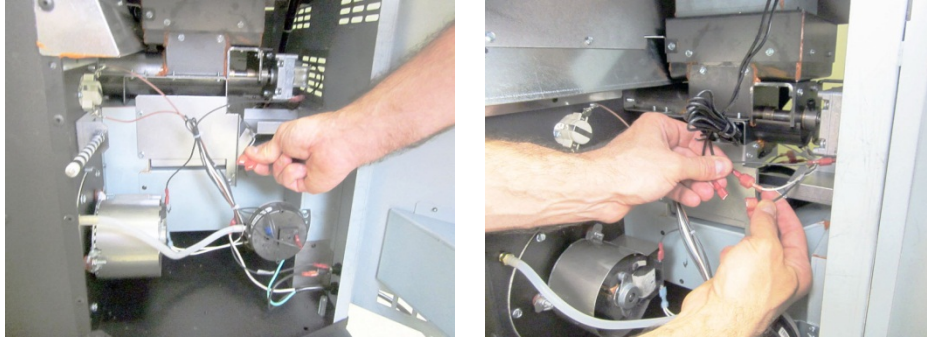

14. Replace and secure the right side access panel and side cover.
15. Program the receiver to the remote according to the instructions in the receiver box.

# Safety Label



**WARNING - DO NOT REMOVE OR COVER THIS LABEL**

SERIAL NO:

**MODEL: AGP PS**

Listed Pelletized Solid Fuel Burning Appliance  
Also for use in mobile homes  
Certified for US and Canada



Conforms to ASTM E1509-04, Room Heater Pellet Burning Type (UM) 84 HUD; Certified to ULC S627  
Electrical Rating: 115 V, 60 Hz, 3 Amp; Start 3 Amps, Run 2.2 Amps with blower on High  
Maximum Input Rating: 5.0 lbs/hr

This pellet fired appliance has been tested and listed for use in manufactured (mobile) homes in accordance with OAR 814-23-900 through 814-23-909.

**WARNING - FOR MANUFACTURED HOMES:** Must utilize outside combustion air inlet (part #99200136) or equivalent. Structural integrity of the manufactured home floor, ceiling and walls must be maintained.

Install only in accordance with the manufacturer's installation and operating instructions. Contact local building or fire officials about restrictions and installation inspection in your area. Use only 3 in. / 77 mm diameter listed type "L" or "PL" venting system. See manufacturer's installation instructions and local codes for precautions required for passing chimney through a combustible wall or ceiling. Do not connect this appliance to a chimney flue serving another appliance. Inspect and clean exhaust venting system frequently in accordance with manufacturer's instructions.

May be installed in a sleeping room with use of outside combustion air inlet (Part #99200136) or equivalent.

For use with 1/4 in. / 6 mm to 5/16 in. / 7 mm diameter pelletized wood fuels only.

Replace glass only with 5 mm ceramic glass available from your dealer.

**DANGER:** Risk of electrical shock. Disconnect power supply before servicing. Route power cord away from unit. Do not route power cord beneath heater.

Operate only with viewing door and ash removal tray tightly closed. Do not obstruct combustion air openings. The space beneath heater must not be obstructed. Keep all furnishings away from heater.

**Minimum Clearance to Combustible Materials (Measured to Stove Top)**

	Interior Vertical Flue Installation	Horizontal Through the Wall Installation
Side wall	A 6 in. / 153 mm	6 in. / 153 mm
Rear wall	B **	3 in. / 77 mm
Corner	C 3 in. / 77 mm	3 in. / 77 mm
Flue Vent	D 2 in. / 51 mm **	2 in. / 51 mm **

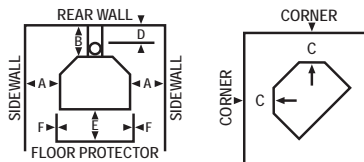

Manufactured by:



Maximum alcove depth 48 in. / 1220 mm, minimum ceiling height 60 in. / 1524 mm, minimum alcove width 36-9/16 in. / 929 mm.

Combustible floor must be protected by a non-combustible material underneath appliance, extending to the front (E) 6 in. / 150 mm and to the sides (F) 0 in. / 0 mm.

**EXCEPTIONS:** Non-combustible floor protection must extend beneath a vent tee when installed.

\*\* This dimension will vary depending on brand of listed type "L" vent. See manual for details.

**U.S. ENVIRONMENTAL PROTECTION AGENCY:** This model is exempt from EPA certification under 40 CFR 60.531 by definition [Wood Heater (A) "Air-to-fuel Ratio"].

DATE OF MANUFACTURE

2012	2013	2014	Jan.	Feb.	Mar.	Apr.	May	June	July	Aug.	Sep.	Oct.	Nov.	Dec.
■	■	■	■	■	■	■	■	■	■	■	■	■	■	■

1000



# Limited 7 Year Warranty

# 49

To register your TRAVIS INDUSTRIES, INC. 7 Year Warranty, complete the enclosed warranty card and mail it within **ten (10)** days of the appliance purchase date to: TRAVIS INDUSTRIES, INC., 12521 Harbour Reach Drive, Mukilteo, WA 98275. TRAVIS INDUSTRIES, INC. warrants this appliance (appliance is defined as the equipment manufactured by Travis Industries, Inc.) to be defect-free in material and workmanship to the original purchaser from the date of purchase as follows:

Check with your dealer in advance for any costs to you when arranging a warranty call.  
Mileage or service charges are not covered by this warranty. This charge can vary from store to store.

## Years 1 & 2 - COVERAGE: PARTS & LABOR

### Firebox Assembly:

Fire platform, Fire platform Holder, Ash Cleanout Doors, Ashbox or Ash Dump, Heat Exchanger Tubes, Exhaust Manifold, Exhaust Box

### Door Assembly:

Door Frame, Latch Assembly, Glass Retainers

Auger Assembly: Auger Flight, Auger Tube, Auger Bushings

**Exclusions:** Paint, Gasketing

### Ceramic Glass

Glass (breakage from thermal shock)

### Igniter System

Igniter, Igniter Leads

Electrical System Auger Motor, Convection Blower, Exhaust Blower, Circuit Board, Snap Disks, Wiring Harness, Vacuum Switch

### Re-Installation Allowance

In cases where heater must be removed from home for repairs, a partial cost of re-installation is covered (pre-authorization required)

One-Way Freight Allowance One-way freight allowance on pre-authorized repair done at factory is covered.

## Years 3 Through 5 - COVERAGE: PARTS & LABOR

Firebox Assembly: Fire platform, Fire platform Holder, Ash Cleanout Doors, Ashbox or Ash Dump, Cast Fireback, Heat Exchanger Tubes, Exhaust Manifold, Exhaust Box

Door Assembly: Door Frame, Latch Assembly, Glass Retainers

Auger Assembly Auger Flight, Auger Tube, Auger Bushings

One-Way Freight Allowance One-way freight allowance on pre-authorized repair done at factory is covered.

**Exclusions:** Paint, Gasketing, Ceramic Glass, Igniter System, Electrical System, Cast Iron Parts, Accessories, Re-Installation Allowance

## Years 6 & 7 - COVERAGE: PARTS ONLY

Firebox Assembly: Fire platform, Fire platform Holder, Ash Cleanout Doors, Ashbox or Ash Dump, Heat Exchanger Tubes, Exhaust Manifold, Exhaust Box

Door Assembly: Door Frame, Latch Assembly, Glass Retainers

**Exclusions:** Paint, Gasketing, Ceramic Glass, Igniter System, Electrical System, Auger Assembly, Re-Installation Allowance, One-Way Freight Allowance, Labor

## CONDITIONS & EXCLUSIONS

- This new appliance must be installed by a qualified installer. It must be installed, operated, and maintained at all times in accordance with the instructions in the Owner's Manual. Any alteration, willful abuse, accident, neglect, or misuse of the product shall nullify this warranty.
- This warranty is nontransferable, and is made to the ORIGINAL purchaser, provided that the purchase was made through an authorized Travis dealer.
- Discoloration and some minor expansion, contraction, or movement of certain parts and resulting noise, is normal and not a defect and, therefore, not covered under warranty.
- The warranty, as outlined within this document, does not apply to the chimney components or other Non-Travis accessories used in conjunction with the installation of this product. If in doubt as to the extent of this warranty, contact your authorized Travis retailer before installation.
- Travis Industries will not be responsible for inadequate performance caused by environmental conditions such as nearby trees, buildings, roof tops, wind, hills or mountains or negative pressure or other influences from mechanical systems such as furnaces, fans, clothes dryers, etc.
- This Warranty is void if:
  - The unit has been operated in atmospheres contaminated by chlorine, fluorine or other damaging chemicals.
  - The unit is subject to submersion in water or prolonged periods of dampness or condensation.
  - Any damage to the unit, combustion chamber, heat exchanger or other components due to water, or weather damage which is the result of, but not limited to, improper chimney/venting installation.
- Exclusions to this 7 Year Warranty include: injury, loss of use, damage, failure to function due to accident, negligence, misuse, improper installation, alteration or adjustment of the manufacturer's settings of components, lack of proper and regular maintenance, damage incurred while the appliance is in transit, alteration, or act of God.
- This 7 Year warranty excludes damage caused by normal wear and tear, such as paint discoloration or chipping, worn or torn gasketing, chipped or cracked firebrick, etc. Also excluded is damage to the unit caused by abuse, improper installation, modification of the unit, or the use of fuel other than that for which the unit is configured.
- Damage to gold or nickel surfaces caused by fingerprints, scratches, melted items, or other external sources left on the gold or nickel from the use of cleaners other than denatured alcohol is not covered in this warranty.
- TRAVIS INDUSTRIES, INC. is free of liability for any damages caused by the appliance, as well as inconvenience expenses and materials. Incidental or consequential damages are not covered by this warranty. In some states, the exclusion of incidental or consequential damage may not apply.
- This warranty does not cover any loss or damage incurred by the use or removal of any component or apparatus to or from the Travis appliance without the express written permission of TRAVIS INDUSTRIES, INC. and bearing a TRAVIS INDUSTRIES, INC. label of approval.
- Any statement or representation of Travis products and their performance contained in Travis advertising, packaging literature, or printed material is not part of this 7 year warranty.
- This warranty is automatically voided if the appliance's serial number has been removed or altered in any way. If the appliance is used for commercial purposes, it is excluded from this warranty.
- No dealer, distributor, or similar person has the authority to represent or warrant Travis products beyond the terms contained within this warranty. TRAVIS INDUSTRIES, INC. assumes no liability for such warranties or representations.
- Travis Industries will not cover the cost of the removal or re-installation of hearths, facing, mantels, venting or other components.
- If for any reason any section of this warranty is declared invalid, the balance of the warranty remains in effect and all other clauses shall remain in effect.
- This 7 year warranty is the only warranty supplied by Travis Industries, Inc., the manufacturer of the appliance. All other warranties, whether express or implied, are hereby expressly disclaimed and purchaser's recourse is expressly limited to the warranties set forth herein.

**IF WARRANTY SERVICE IS NEEDED:**

1. If you discover a problem that you believe is covered by this warranty, you **MUST REPORT** it to your Travis dealer **WITHIN 30 DAYS**, giving them proof of purchase, the purchase date, and the model name and serial number.
2. Travis Industries has the option of either repairing or replacing the defective component.
3. If your dealer is unable to repair your appliance's defect, he may process a warranty claim through TRAVIS INDUSTRIES, INC., including the name of the dealership where you purchased the appliance, a copy of your receipt showing the date of the appliance's purchase, and the serial number on your appliance. At that time, you may be asked to ship your appliance, freight charges prepaid, to TRAVIS INDUSTRIES, INC. TRAVIS INDUSTRIES, INC., at its option, will repair or replace, free of charge, your appliance if it is found to be defective in material or workmanship within the time frame stated within this 7 year warranty. TRAVIS INDUSTRIES, INC. will return your appliance, freight charges (years 1 to 5) prepaid by TRAVIS INDUSTRIES, INC., to your regional distributor, or dealership.
4. Check with your dealer in advance for any costs to you when arranging a warranty call. Mileage or service charges are not covered by this warranty. This charge can vary from store to store.



Adjust the Latch .....	41	Installation Example: Masonry Fireplace Hearth Stove .....	18
Alcove Installation Requirements.....	14	Installation Example: Zero-Clearance (Metal) Fireplace Hearth Stove .....	19
Before You Begin .....	8	Installation Options .....	8
Changing the TSTAT Program.....	26	Installing the Pellet Vent .....	12
Check for Air Leaks Around the Door, Glass, and Ashdump .....	41	Introduction .....	2
Checking the Ashpan .....	36	Loading Pellets .....	22
Clean the Convection Blower.....	39	Location of Controls.....	21
Clean the Fire platform.....	30	Manual Mode .....	23
Clean the Firebox Liners .....	34	Maximum Venting Distance .....	11
Clean the Glass.....	35	Mobile Home Requirements .....	13
Clean the Heat Exchange Tubes .....	33	Opening the Door.....	29
Clean the Lower Exhaust Duct .....	37	Outside Air.....	13
Clean the Vent .....	40	Packing List.....	8
Clearances .....	10	Pellet Vent Termination .....	12
Corner Installations .....	10	Pellet Vent Type.....	12
Curing the Paint .....	22	Planning the Installation.....	9
Dimensions .....	7	Power Outages .....	27
Disposing Ashes .....	28	Restrictor Adjustment .....	14
Electrical Specifications .....	7	Safety Notice.....	21
EPA Compliance .....	7	Starting the Heater for the First Time .....	22
Floor Protection Requirements .....	9	Start-Up Sequence .....	27
Fuel .....	7	Stove Maintenance .....	28
Heating Specifications.....	7	Stove Maintenance Tools .....	29
Important Information .....	2	Stove Placement.....	9
Inspect the Burn .....	30	Stove Tool Storage .....	29
Installation Example: Class "A" Chimney Retrofit .....	17	Straight Installations .....	10
Installation Example: Direct "Through-the-wall" Installation .....	15	Troubleshooting Table .....	42
Installation Example: Freestanding Masonry Chimney .....	20	Tstat Mode .....	25
Installation Example: Interior Vertical Installation .....	16	Venting the Pellet Stove .....	11
		Wireless Thermostat Installation.....	44
		Yearly Maintenance - Clean the Negative Pressure Tube.....	40