

Direct Venting Systems for B-10 and
SG Oil Fired Boilers From QHT INC.

QHT-DV

Direct Vent Addendum - Oil

For use in conjunction with B-10, or SG atmospheric venting manuals

QHT DV— OIL

**Please Read Instructions Carefully
Save for Future Reference**

WARNING

If the information in this manual is not followed exactly, a fire explosion may result causing property damage, personal injury or loss of life.

DANGER

DO NOT store or use gasoline or other flammable vapors or liquids in the vicinity of this or any other appliance.

WHAT TO DO IF YOU SMELL GAS VAPORS

- Do not try to light any appliance
- Do not touch any electric switch; do not use any phone in your building
- Immediately call your gas supplier from a neighbors phone.
- If you can not reach your gas supplier call the fire department

Installation and service must be performed by a qualified installer, service agency or the gas supplier.

QUINCY HYDRONIC TECHNOLOGY, INC.

3560 LAFAYETTE RD

PORTSMOUTH, NH 03801

PHONE: 603-334-6400

FAX: 603-334-6401



REV. F

TABLE OF CONTENTS

QHT INC. OIL DIRECT VENT PACKAGES	Section	Page
Important Info & Warnings		1-3
General Information & Installation		
Explosions	1	4-5
Vent System Installation	2	6
External Clearances		6
Clearances to Combustibles		7
DVH-5 System	2.1	8
Installation of Make-up Air	2.2	9
Burner Setup Installations	3	10
B-10 Burner Setup	3.1	11
SG Burner Setup	3.2	12
Wiring	4	13-17
System Start Up	5	18-19
Installation Inspection	6	19
Service and Maintenance	7	20
Installer and Customer Notes		

IMPORTANT INFORMATION

ALL BOILERS MUST BE INSTALLED IN ACCORDANCE WITH NATIONAL, STATE AND LOCAL PLUMBING, HEATING AND ELECTRICAL CODES AND ORDINANCES, AS WELL AS THE REGULATIONS OF THE SERVING ELECTRICAL, WATER AND GAS UTILITIES.

All systems should be designed by competent contractors, and only persons knowledgeable in the layout and installation of heating systems should attempt the installation of any boiler.

It is the responsibility of the installing contractor to see that all controls are correctly installed and operating properly when the installation is completed.

Do not burn volatile garbage, gasoline, naphtha or other flammable liquids other than No. 2 fuel oil. All flammable liquids (especially gasoline), chemicals, rags, paper, wood scraps, debris, etc., should be kept away from the boiler at all times. Keep the boiler area clean and free of all fire hazards.

Please read the literature and warranties supplied by the manufacturers of the various accessory equipment. This equipment is warranted by the respective manufacturers, not by Quincy Hydronic Technologies, Inc. Each piece of equipment must be installed and used according to the recommendations of the manufacturer.

Codes and Regulations:

Installation of the boiler, burner, oil tank and related equipment must conform to national, state and local regulating agencies and codes applicable to the installation of the equipment. In the absence of local requirements, the following codes apply:

- A. ANSI/NFPA - #31 Installation of Oil Burning Equipment
- B. ANSI/NFPA - #70 National Electric Code
- C. ANSI/NFPA - #211 Chimneys and Vents
- D. ANSI/NFPA - #Z223.1 National Fuel Gas Code
- E. ANSI/NFPA - Domestic Gas Conversion Burner
- F. CAN/CGA B149

The above codes are available from:

National Fire Protection Association (NFPA)
Battery March Park
Quincy, Massachusetts 02269
OR

<http://www.nfpa.org>

American Gas Association (AGA)
Pleasant Valley Road
Cleveland, OH 44134
OR [HTTP://www.aga.org](http://www.aga.org)

WARNING

- ALL BOILERS MUST BE INSTALLED IN ACCORDANCE WITH NATIONAL, STATE AND LOCAL PLUMBING, HEATING AND ELECTRICAL CODES AND ORDINANCES, AS WELL AS THE REGULATIONS OF THE SERVING ELECTRICAL, WATER AND GAS UTILITIES.
- Improper installation, adjustment, or maintenance of this boiler can cause property damage, personal injury or death. Due to this fact only experienced technicians and installers may install or adjust BIASI boilers. All systems should be designed by competent contractors, and only persons knowledgeable in the layout and installation of heating systems should attempt the installation of any boiler. The homeowner should never tamper with any part of the boiler.
- Thoroughly read and understand all instructions including the B-10 or SG atmospheric venting instructions before beginning this installation.
- After installation place this manual in a safe place in plain view of the boiler. If the manual is no longer legible contact QHT INC. for a new manual.
- After the boiler is installed and in working order, it should be serviced once a year before each heating season. Service on the boiler may only be done by an experienced installer or oil heating technician.
- These boilers may only be direct vented using approved venting systems supplied through QHT INC. For the boiler warranty, please consult the B-10 or SG atmospheric venting manual.
- **Do not burn volatile garbage, gasoline, naphtha or other flammable liquids other than No. 2 fuel oil. All flammable liquids (especially gasoline), chemicals, rags, paper, wood scraps, debris, etc., should be kept away from the boiler at all times. Keep the boiler area clean and free of all fire hazards.**
- Please read the literature and warranties supplied by the manufacturers of the various accessory equipment. This equipment is warranted by the respective manufacturers, not by Quincy Hydronic Technologies, Inc. Each piece of equipment must be installed and used according to the recommendations of the manufacturer

WARNING

Any appliance that burns natural gas, propane gas, fuel oil, wood or coal is capable of producing carbon monoxide (CO). Carbon Monoxide (CO) is a gas which is odorless, colorless and tasteless but is very toxic.

If your BIASI boiler is not working properly, or is not vented properly, dangerous levels of CO may accumulate. CO is lighter than air and thus may travel throughout the building. **BRIEF EXPOSURE TO HIGH CONCENTRATIONS OF CO, OR PROLONGED EXPOSURE TO LESSER AMOUNTS OF CO MAY RESULT IN CARBON MONOXIDE POISONING. EXPOSURE CAN BE FATAL AND EXPOSURE TO HIGH CONCENTRATIONS MAY RESULT IN THE SUDDEN ONSET OF SYMPTOMS INCLUDING UNCONSCIOUSNESS.**

Symptoms of CO poisoning include the following:

dizziness	vision problems	shortness of breath
headache	loss of muscle control	unclear thinking
nausea	weakness	unconsciousness

The symptoms of CO poisoning are often confused with those of influenza, and the highest incidence of poisoning occurs at the onset of cold weather or during flu season. A victim may not experience any symptoms, only one symptom, or a few symptoms. **Suspect the presence of carbon monoxide if symptoms tend to disappear when you leave your home.**

The following signs may indicate the presence of carbon monoxide:

- * Hot gasses from appliance, venting system, pipes or chimney, escaping into the living space.
- * Flames coming out around the appliance.
- * Yellow colored flames in the appliance.
- * Stale or smelly air.
- * The presence of soot or carbon in or around the appliance.
- * Very high unexplained humidity inside the building.

If any of the symptoms of CO occur, or if any of the signs of carbon monoxide are present, **VACATE THE PREMISES IMMEDIATELY AND CONTACT A QUALIFIED HEATING SERVICE COMPANY OR THE GAS COMPANY OR THE FIRE DEPARTMENT.**

To reduce the risk of CO poisoning, have your heating system "tuned up" by a licensed heating contractor or the gas company - preferably before each heating season. Also have the service company check your chimney or vent pipes for blockage.

Your home should also be adequately ventilated, particularly if you have insulated your home.

ONLY QUALIFIED, LICENSED SERVICE CONTRACTORS SHOULD PERFORM WORK ON YOUR B-10 OR SG BOILER.

1. General Information

The QHT Direct Vent components have been designed and packaged so that the Biasi B-10 and SG boilers can be directly vented to the outside. Properly maintained, these boiler systems are unsurpassed in efficiency and will provide years of trouble-free operation.

In addition to the standard Biasi boiler package, the Direct Vent Package is supplied with a kit containing the standard make-up air and appropriate exhaust system piping and hoods for your application. The last piece of the complete package is a direct vent specific burner.

The Direct Vent Systems are a non-powered positive pressure vent hood system for gas or oil fired appliances that provides an outlet for exhaust gases and an intake for combustion air. The hood is designed to direct the hot exhaust gases away from the structure without the aid of a motorized fan. All of the internal parts in contact with the flue gases are made from corrosion resistant stainless steel.

NOTICE:

All equipment should be inspected upon delivery, and any damage or shortage should be reported to the supplier and shipper immediately.

OHT DIRECT VENT OIL KITS

DVH-5 Vent System

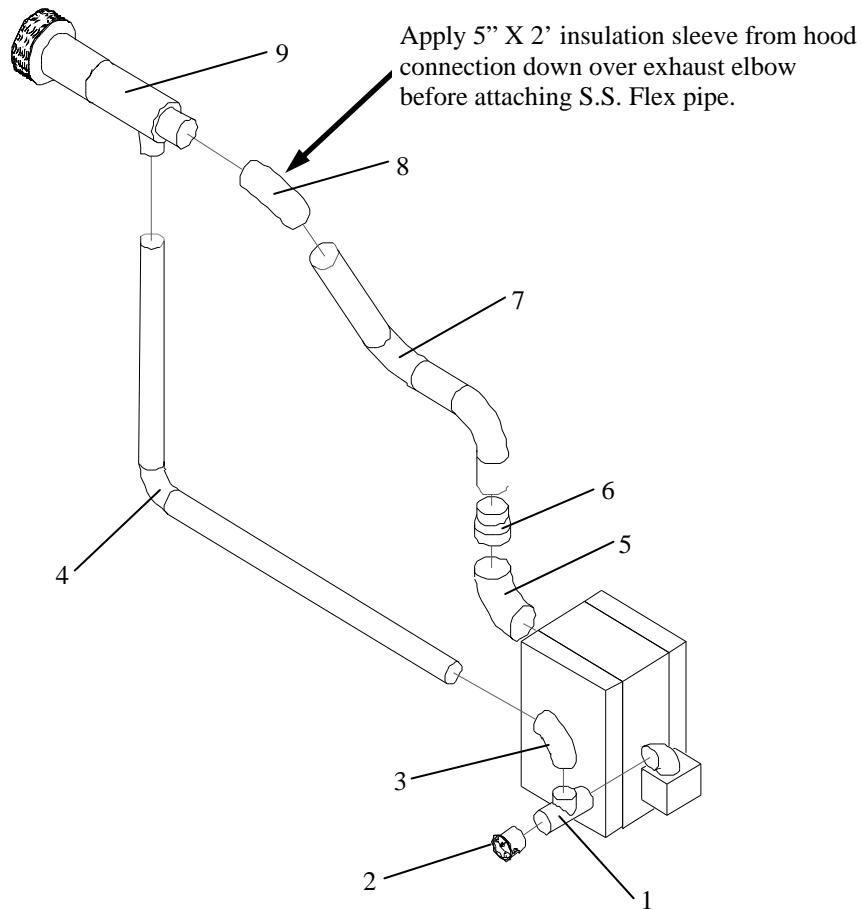

#	DESCRIPTION	PART #
1	4" Tee	D-4"TEE
2	4" Barometric Damper	D-4"DAMP
3	4" 90° Light Gauge Elbow	D-4"ELB
4	4" X 8' Aluminum Flex Duct	D-4"ALUFLEX
5	6" 90° Vent Elbow	D-6"ELBSS
6	6" to 5" Double Wall Flexible Decreaser	D-6-5FLEXADAP
7	5" X 8' Stainless Steel Double Wall Flex Pipe	D-5"SSDWFLEX
8	5" Double Wall Flex Adapter	D-5"FLEXADAP

#	DESCRIPTION	PART #
9	5" 90° Vent Elbow	D-5"ELBSS
10	5" Concentric Vent Hood	D-5"CONHOOD
11	5" X 2' Insulation Sleeve for Exhaust Hood Elbow	D-INSULSLEEVE
12	1½ x ½ x 1½ Bull-Head Tee	D-1006010
13	L4006A Aquastat	D-4006A
14	1/2" Immersion Well	D-1/2"WELL
15	High Temp Sealant	D-SEALANT

2. Installation of DV Hood

CAUTION:

EXTERNAL VENT SURFACES ARE HOT.

NOTE:

USE ONLY LISTED COMPONENTS SUPPLIED WITH THE BOILER. SURFACE DISCOLORATION OF THE BUILDING MAY OCCUR DUE TO IMPROPER BOILER/BURNER ADJUSTMENT. QHT WILL NOT ACCEPT RESPONSIBILITY OR LIABILITY FOR SUCH DISCOLORATION.

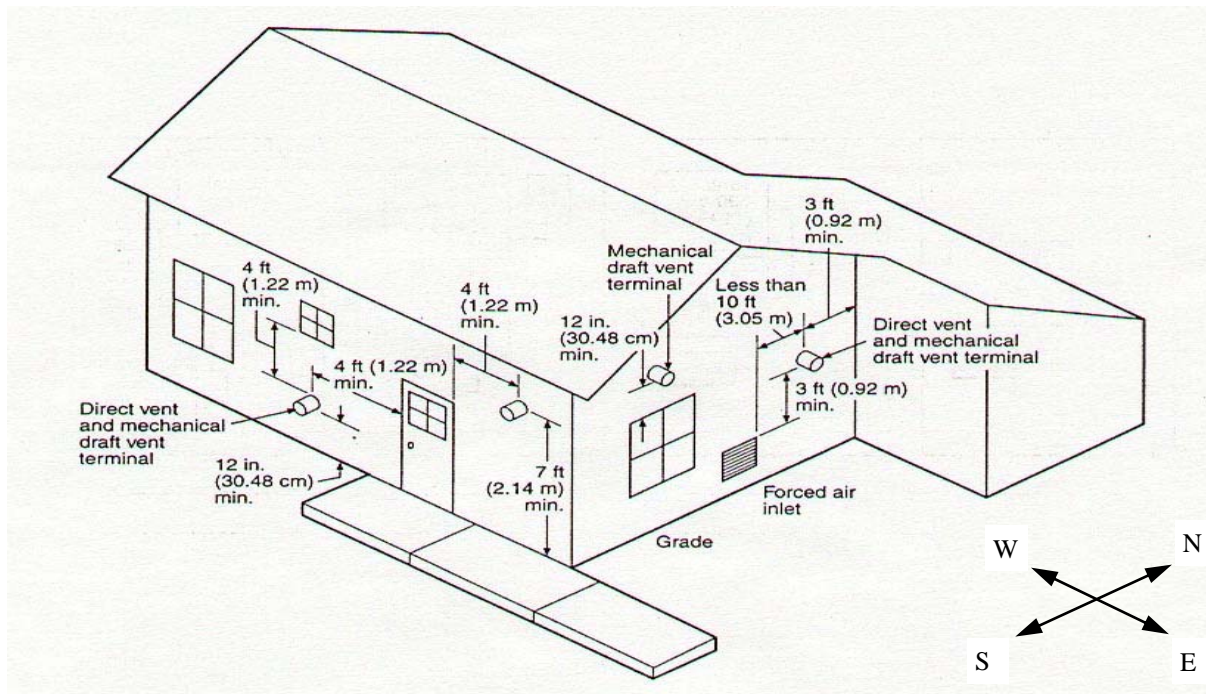

The Exhaust Hood must be installed on the leeward side of house and conform to the following guidelines:

1. The Vent hood shall be installed 12" above ground level or 12" above nominal snow level of the region of the installation.
2. The Vent hood shall not be less than 3 feet above any forced air inlet to the house.
3. The Vent hood shall not be less than 4 feet below, 4 feet horizontally, or 1 foot above any door, window or gravity inlet into any building.
4. The Vent hood shall not be less than 2 feet from an adjacent building.
5. The Vent hood shall be not less than 7 feet above grade when located adjacent to public walkway.
6. The Vent hood shall be located so that flue gasses are not directed to jeopardize people, overheat combustible structures, materials or enter buildings.
7. Minimum of 4' horizontal clearance from electric meters, gas meters, regulators and relief equipment.
8. All joints in system are to be sealed to prevent leakage of products of combustion in the building.
9. Avoid installing exhaust hood on North, West, or prevailing wind side of the house.

NOTE

The boiler shall be placed so that the vent pipe is as short as practical. The **VENT HOOD** must be installed at least one foot above ground level or normal snow accumulation level in an area which is free of obstruction at all times. The Vent hood should be installed on the leeward side of the house out of the wind. Outside air must be ducted directly to the burner through the hood unit supplied. **The Direct Vent System must be gas tight.**

CLEARANCES TO COMBUSTIBLES

SYSTEM OPERATING TEMP.	Clearance		Sealant Required
	Horizontal	Vertical	
Vent Kit			
Single Wall Rigid	16" (25 mm)	16" (400 mm)	G.E. 108 Dow Corning 732 Z-Flex Z-Vent Sealant
Double Wall Flexible	1" (25 mm)	1" (100 mm)	G.E. 106 Z-Flex Z-Vent Sealant

Note: Clearances are based on an installation of **Z-Flex OIL VENT COMPONENTS** . Routing of vent pipe can be planned after the termination location is determined.

2.1 Exhaust Pipe System

The B10/SG Direct Vent Systems must be installed where provisions do not exist for the ducting of combustion by products to the outside. **The direct vent connector shall not pass through any floor or ceiling.** The burner exhaust must be ducted directly to the vent hood through listed exhaust pipes provided. The exhaust pipe throughout its entire length must be readily accessible for inspection, cleaning and replacement.

The venting system should be installed and supported in accordance with the National Fuel Gas Code, ANSI Z223.1, CAN/CGA B149 or in accordance with any local codes.

The Exhaust Kit consists of:

DVH-5 System

1 - 6" to 5" Z-Vent Reducer
1 - 5" 90 degree elbow

1 - 5" x 8' Length of stainless flex pipe
1 - 5" Concentric exhaust

Installation of DVH Exhaust:

1. Begin by locating a suitable location for the exhaust to breach the wall. This location should be at least 12" above ground level or the expected snow level, and on the leeward side of the house. Consult page 6 for required distances from windows, doors, etc.. The hood location must also allow for an upward slope of a 1/4" per foot for the exhaust piping.
2. Once the hood location has been determined, cut a 7 1/2" hole through the wall for the vent terminal. Using 2" X 2", Frame a box around the hole on the outside of the house so the flange is mounted away from the siding. Attach the hood to the outside of the house using appropriate screws to support the hood. Use one screw through each of the predrilled holes on the trim plate of the hood. Do not drill or screw through the hood at all.

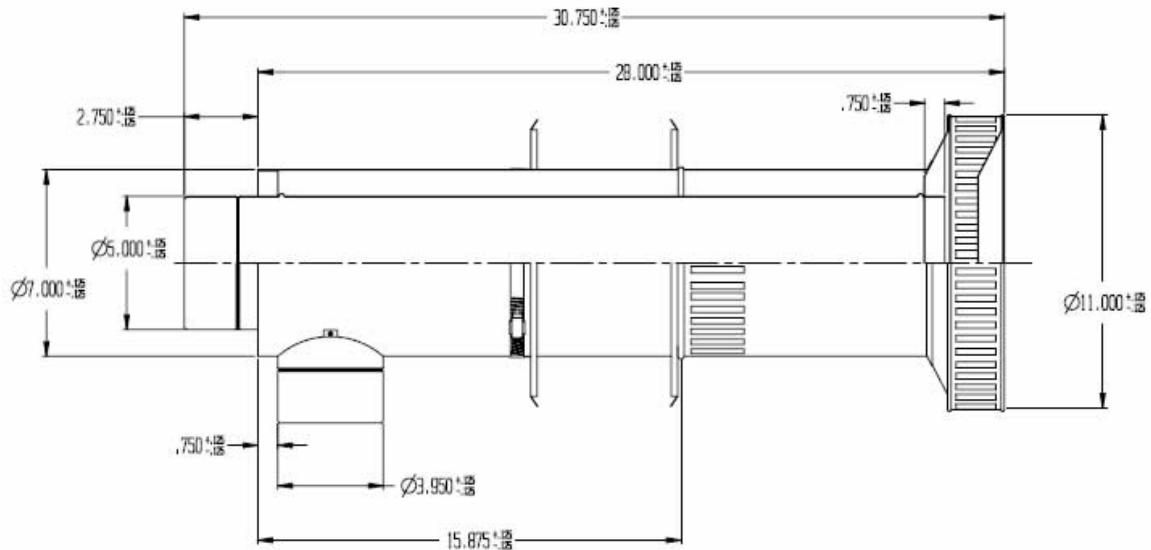

3. Once the hood is secure, mock up the rest of the vent kit. First put the stainless steel elbow on the hood, then install the stainless steel flex pipe between the elbow and the reducer on the breeching of the boiler. Be sure that there is always an upward slope of at least 1/4" per foot of the vent pipe. If at any point the vent pipe is not able to support itself it should be supported from the ceiling.
4. Once you are satisfied with the fit of the exhaust, seal each joint inside and out with high temperature silicone. Secure each joint with three screws and seal the screws as well.
5. When installation is complete, inspect each joint and apply more sealant to any possible leaks.

2.2 Installation of Make-up Combustion Air

NOTICE

Do not operate the burner with air intake disconnected.

For DVH kits:

4. Use 4 inch diameter flex pipe that is provided in the kit or a comparable single wall metal pipe. The maximum allowable length of intake pipe is ten feet not including elbows.
5. Begin installing the 4" tee to the burner (Riello and Heat Wise require the supplied 3" to 4" increaser to be installed first). Secure all joints on the intake with three screws each.
6. Install the supplied vacuum relief damper in the branch of the tee making sure that it is mounted with all labeling right side up and perfectly horizontal.
7. Off of the last leg of the tee install the 4" duct elbow, and then the aluminum flex pipe.
8. Finally attach the other end of the flex pipe to the intake hood or intake port on the concentric hood.
9. Inspect the intake system and make sure all connections are secure and then seal each joint with silicone or aluminum tape.

2.3 Vent System Diagram

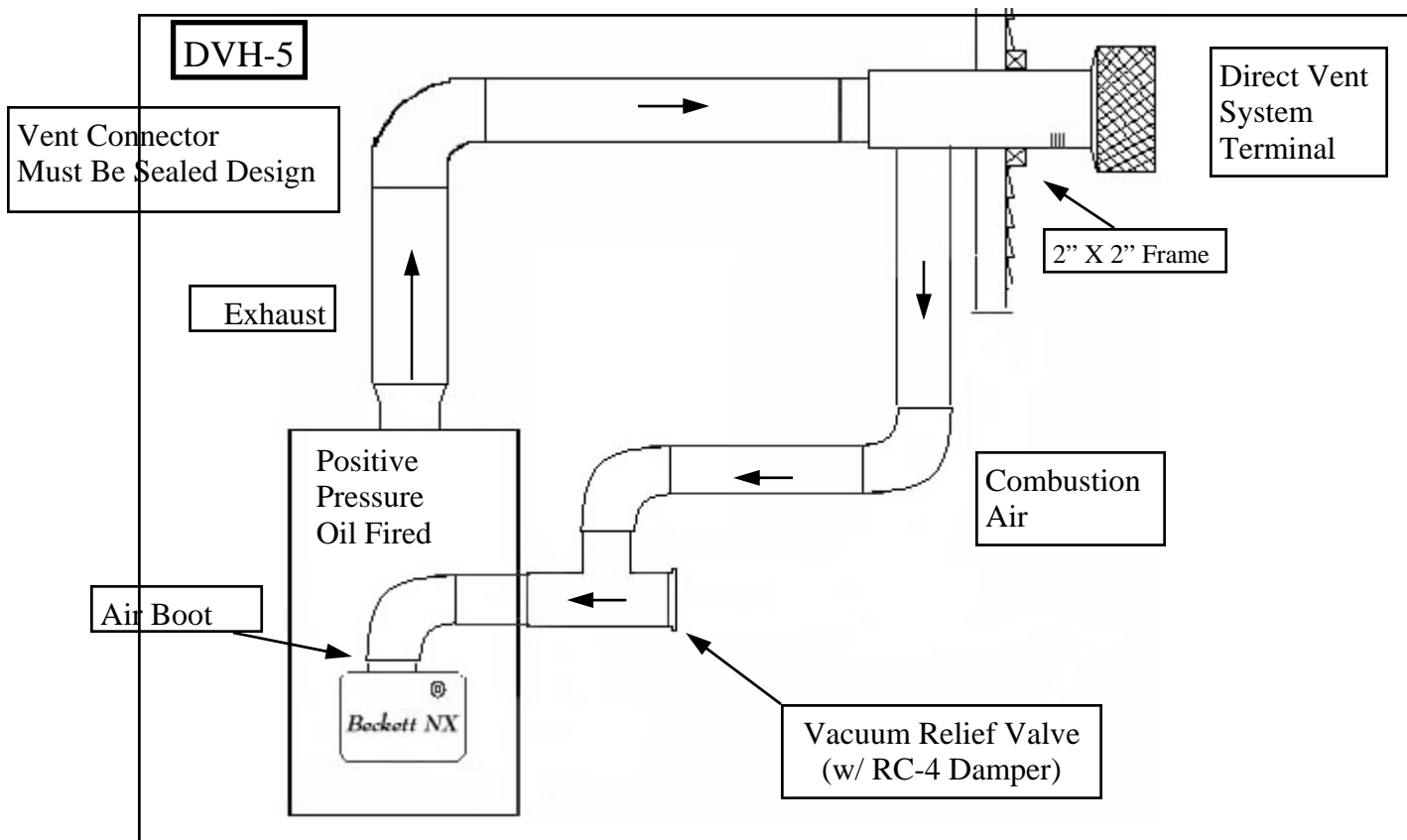

3. Burner Setup

In all boilers, regardless of fuel being burnt or configuration, a 10" X 10" Cerafiber pad should be installed under the flame. This pad is not for acoustic purposes, it is to keep the area under the nozzle warm to prevent flame out.

Good, reliable operation with a minimum of service starts with attention to the small details:

1. Setting the nozzle position and electrodes "by the book" using the manufacturer's gauges.
2. Installing a quality micron filter at the burner.
3. Making careful/tight flare connections without couplings on oil suction line.
4. Checking fuel pump pressure.
5. Checking draft at the breeching to insure it is adequate to overcome flue gas resistance.
6. Setting the air band properly with well maintained instruments. A good target is 11% to 12.5% of (CO₂) or 6.5% to 3.8% of (O₂).

To ensure proper burner setup, gauges should be used to check things such as the pump pressure, CO₂ levels, etc...

3.1 B-10 Burner Setup

BURNER MANUFACTURER **Beckett**
AFII - 150 (NEC 301, 302, 303) , NX (NEC 1101, 1102, 1103)

Boiler Model	B10 - 3*	B10 - 4*		B10 - 5*		B10 - 6*	
Burner Model	NEC - 1102	NEC - 301	NEC - 1101	NEC - 302	NEC - 1101	NEC - 303	NEC - 1103
Firing Rate	0.55	0.80	0.90	1.00	1.00	1.25	1.20
Insertion Depth	3.5"	2.75"	6.0"	2.75"	6.0"	2.75"	6.0"
Nozzle	.40 X 60°	.65 X 60°	.65 X 60°	.85 X 60°	.75 X 60°	1.00 X 60°	.90 X 60°
Spray Pattern	hollow	hollow	solid	solid	solid	solid	W
Pump Pressure	180 psi	160 psi	180 psi	140 psi	180 psi	160 psi	180 psi
Head Type	6 slot	6 slot	9 slot	6 slot	9 slot	9 slot	9 slot
Head Position	1.25	3	3	4	4	5	4.25
Air Setting	N/A	3	N/A	3.75	N/A	6	N/A

BURNER MANUFACTURER **Riello**
BF3 and BF5

Boiler Model	B10-3	B10-4	B10-5	B10-6
Burner Model	BF-3	BF-3	BF-5	BF-5
Firing Rate	0.55	0.80	1.00	1.25
Insertion Depth	3.0"	3.0"	3.0"	3.0"
Nozzle	.4 X 80	.65 X 80	.85 X 60	1.00 X 60
Spray Pattern	W	W	W	W
Pump Pressure	180 psi	175 psi	150 psi	175 psi
Turbulator	2	3	2	3
Air Gate	3.2	4.7	3.4	5

BURNER MANUFACTURER **Heat Wise**
Pioneer

Boiler Model	B-13	B-14	B-15	B-16
Burner Model	P-1 KFV*	P-1 KA	P-1 KA	P-2 KA
Firing Rate	0.55	0.90	1.00	1.25
Insertion Depth	3.5"	3.5"	3.5"	3.5"
Nozzle	0.40 X 80	0.65 X 70	0.85 X 70	1.00 X 80
Spray Pattern	Solid	Solid	Semi Solid	Hollow
Pump Pressure	200	200	150	190
Head Setting	1	1	1	3.75
Air Setting	0	9.5	16.5	6

* 120mm Fan Needed

*** - These burners may not be used in Canada on Biasi equipment**

3.2 SG Burner Setup

BURNER MANUFACTURER Beckett NX (NEC 1201, 1202)

Boiler Model	SG-2*	SG-3*	SG-4*
Burner Model	NEC - 1201	NEC - 1202	NEC - 1202
Firing Rate	0.65	1.00	1.30
Insertion Depth	3.5"	6.0"	6.0"
Nozzle	.50 X 60°	.75 X 60°	1.00 X 60°
Spray Pattern	hollow	solid	solid
Pump Pressure	180 psi	180 psi	180 psi
Head Type	6 slot	9 slot	9 slot
Head Position	1.50	3.50	4.25

BURNER MANUFACTURER Riello BF3 and BF5
--

Boiler Model	SG-2	SG-3	SG-4
Burner Model	BF-3	BF-5	BF-5
Firing Rate	0.65	1.00	1.30
Insertion Depth	5.0"	5.0"	5.0"
Nozzle	.55 X 70	.85 X 60	1.10 X 80
Spray Pattern	solid	solid	solid
Pump Pressure	145 psi	145 psi	145 psi
Turbulator	0	0	2
Air Gate	4.5	4.0	5.6

BURNER MANUFACTURER Heat Wise Pioneer

Boiler Model	SG-2	SG-3	SG-4
Burner Model	P-1 FV	P-1 KA	P-2 KA
Firing Rate	.65	1.00	1.30
Insertion Depth	3.5"	3.5"	3.5"
Nozzle	0.5 X 80	0.75 X 70	1.00 X 80
Spray Pattern	solid	solid	Semi Solid
Pump Pressure	200	200	200
Head Setting	6	3	3
Air Setting	12.0	11.5	11.5

*** - These burners may not be used in Canada on Biasi equipment**

4. Wiring

The electricity to the boiler shall come from a dedicated breaker in the electric service box. A service switch should be mounted on the side of the boiler so the burner technician can service the burner and controls. The electrical wiring should be routed so as not to interfere with normal servicing of the boiler. Wiring done in the field between devices not attached to boiler shall conform with the temperature limitations for type T wire (63F/35C) or other specified wire as applicable when installed in accordance to manufacturer's instructions and wiring diagrams.

If an external electrical source is utilized, the boiler, when installed, must be electrically bonded to ground in accordance with the requirements of the authority having jurisdiction or, in the absence of such requirements, with the National Electrical Code, ANSI/NFPA 70 or Canadian Electrical Code Part I, CSA C22.1, Electrical Code.

The L4006A Post Purge Aquastat is installed to ensure that if the boiler exceeds 200° F all power is disconnected to the burner. The aquastat should be mounted on the supply side of the boiler into the supplied bullhead tee. To wire the post purge aquastat please refer to the schematics for your specific burner on the following pages.

POST PURGE and HIGH LIMIT CONTROL

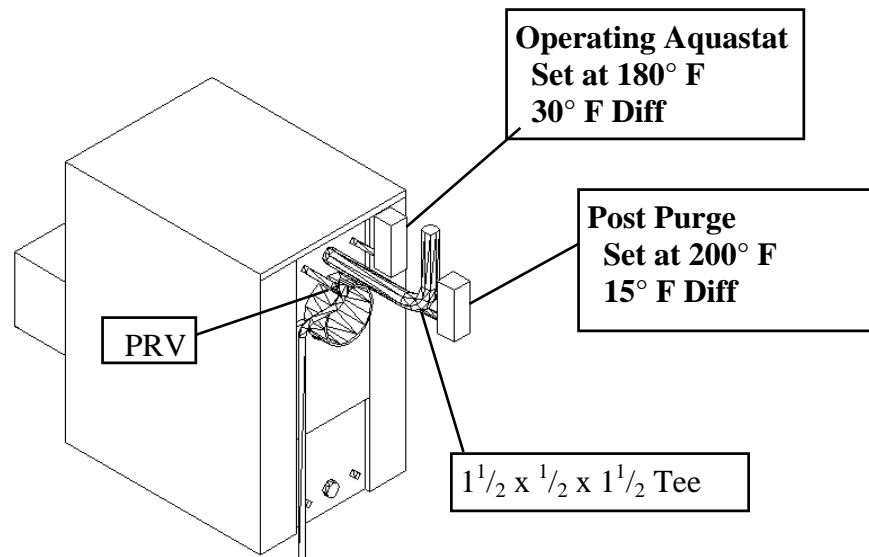

The post purge control (L4006A) must be mounted on the immersion well in 1 1/2 x 1/2 x 1 1/2 tee supplied with DVH Trim Kit.

4. Wiring

Beckett NX/AFill burner, multi-zone, control wiring with DHW Priority

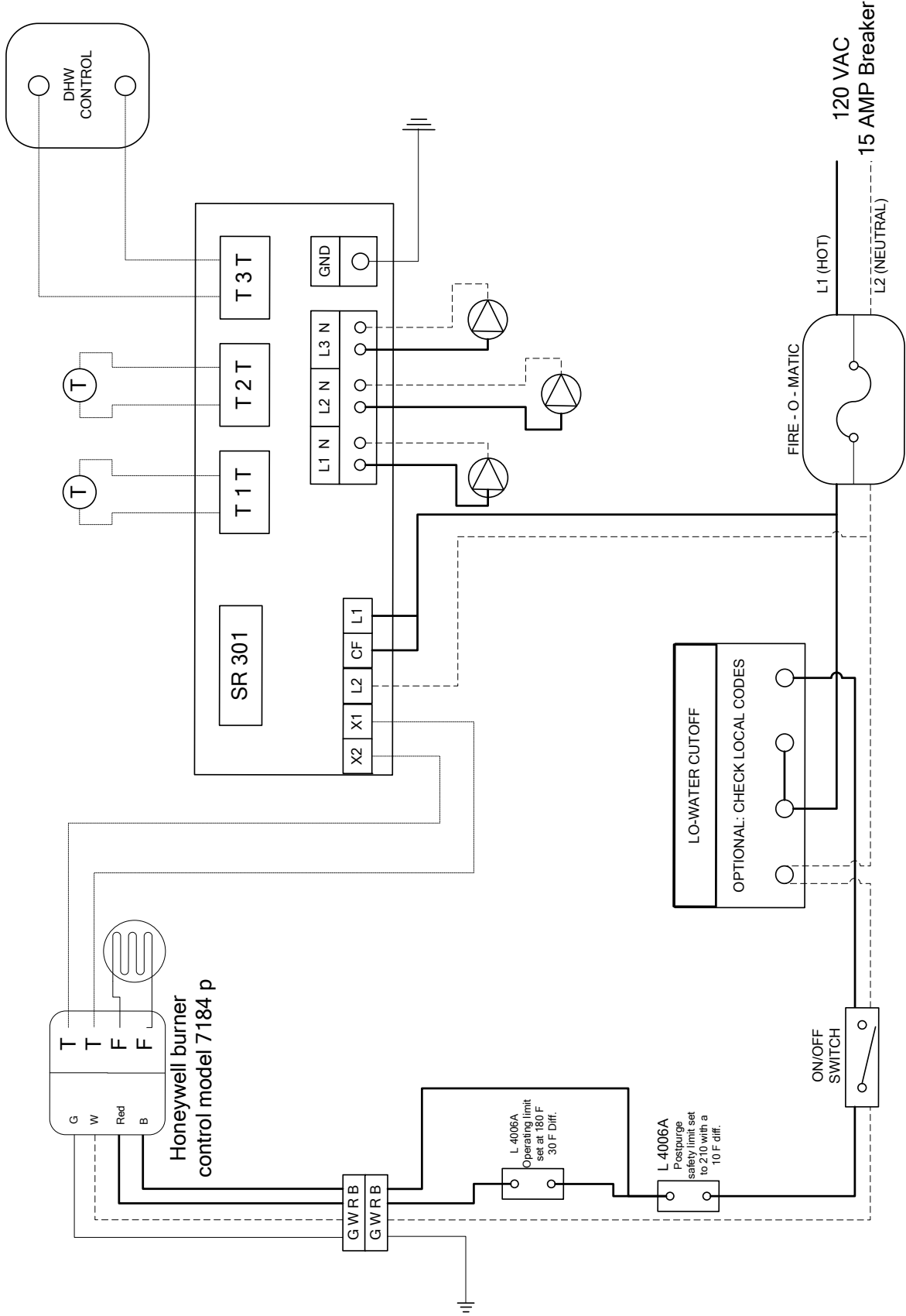

Note 2: All wiring must be done in accordance with applicable state, local and national codes. Use only copper conductors.

Riello Burner without post-purge control multi-zone, control wiring

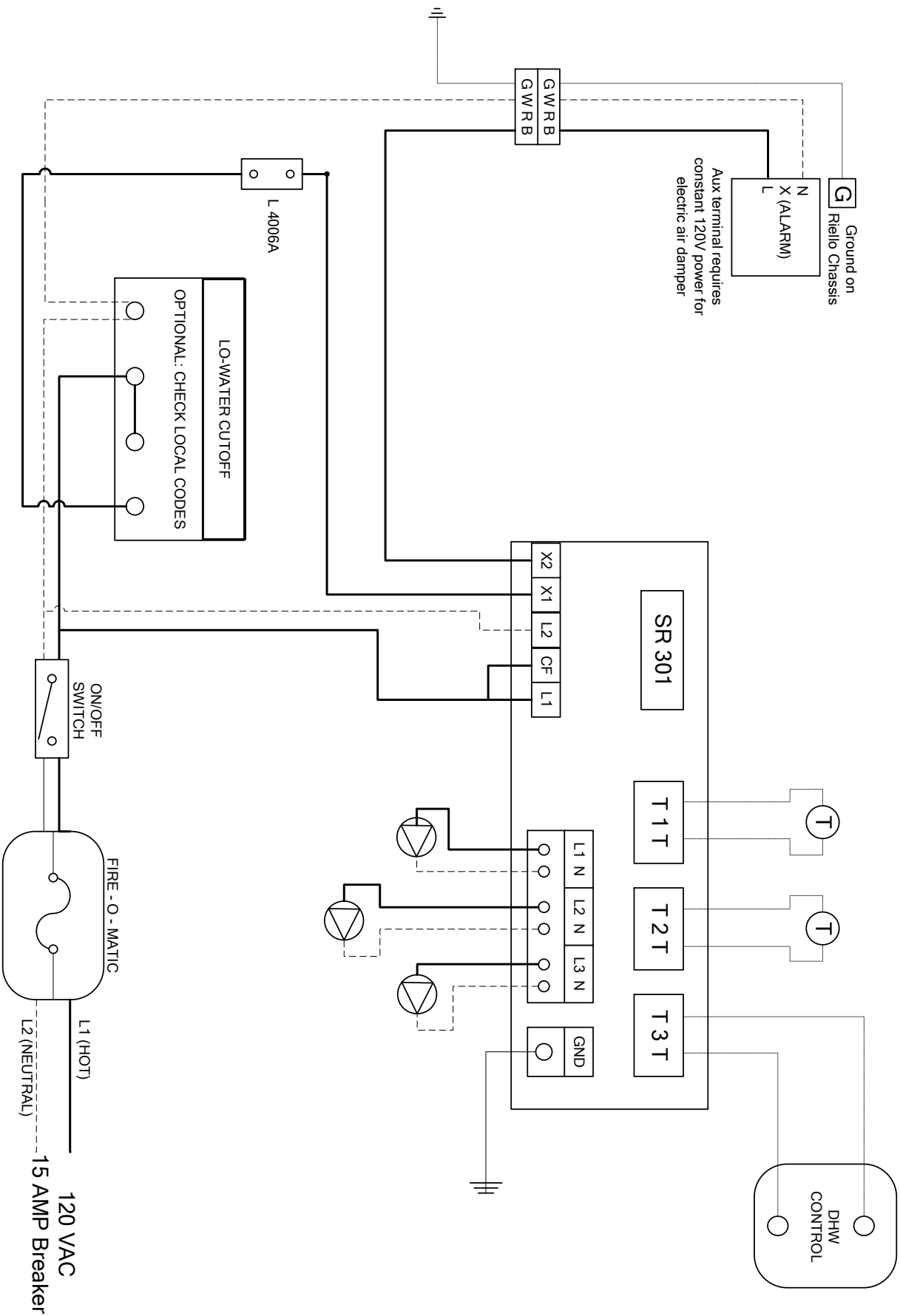

4. Wiring

4. Wiring

Riello Burner with post-purge control multi-zone, control wiring

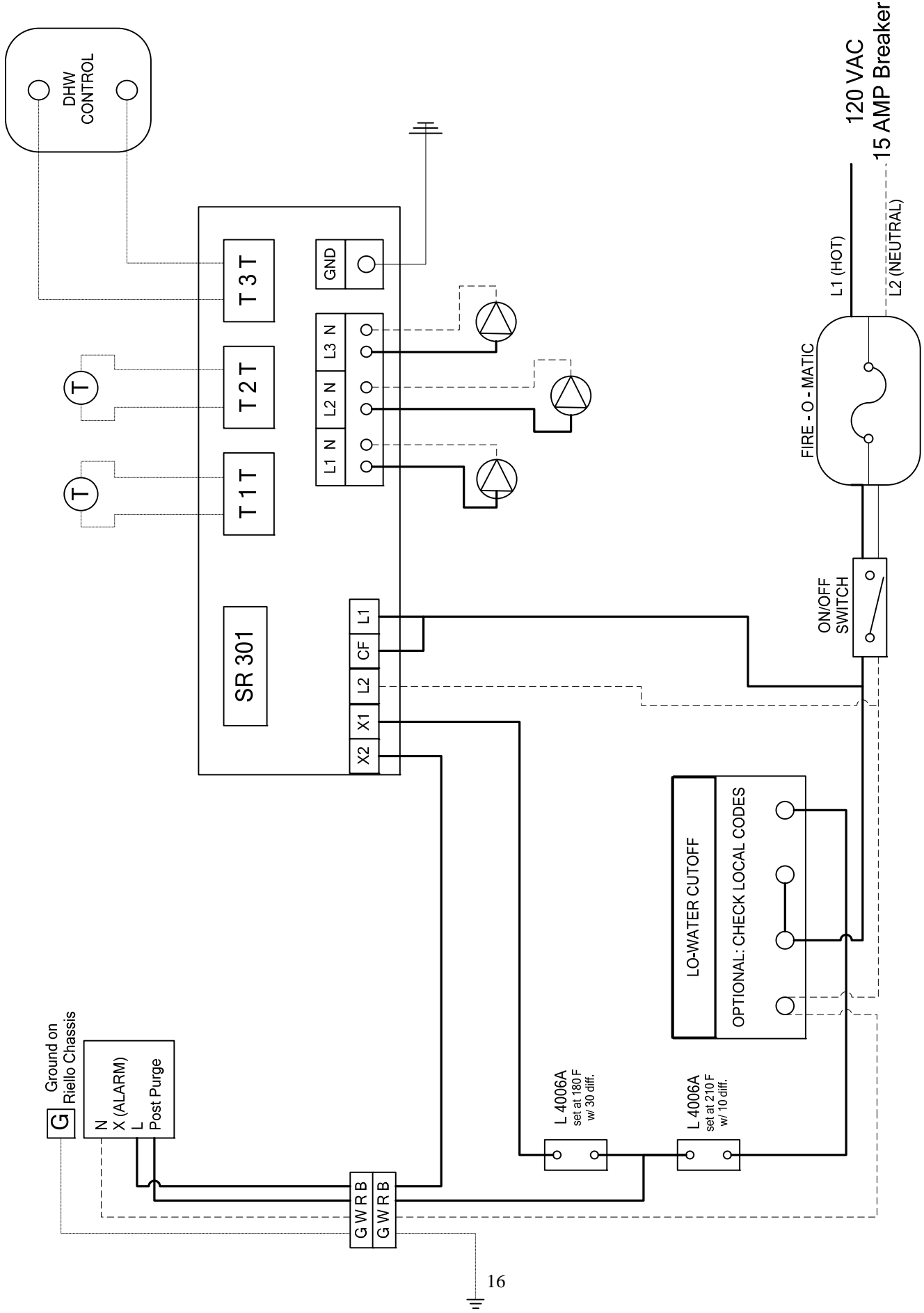

4. Wiring

Heat Wise burner, multi-zone, control wiring with DHW Priority

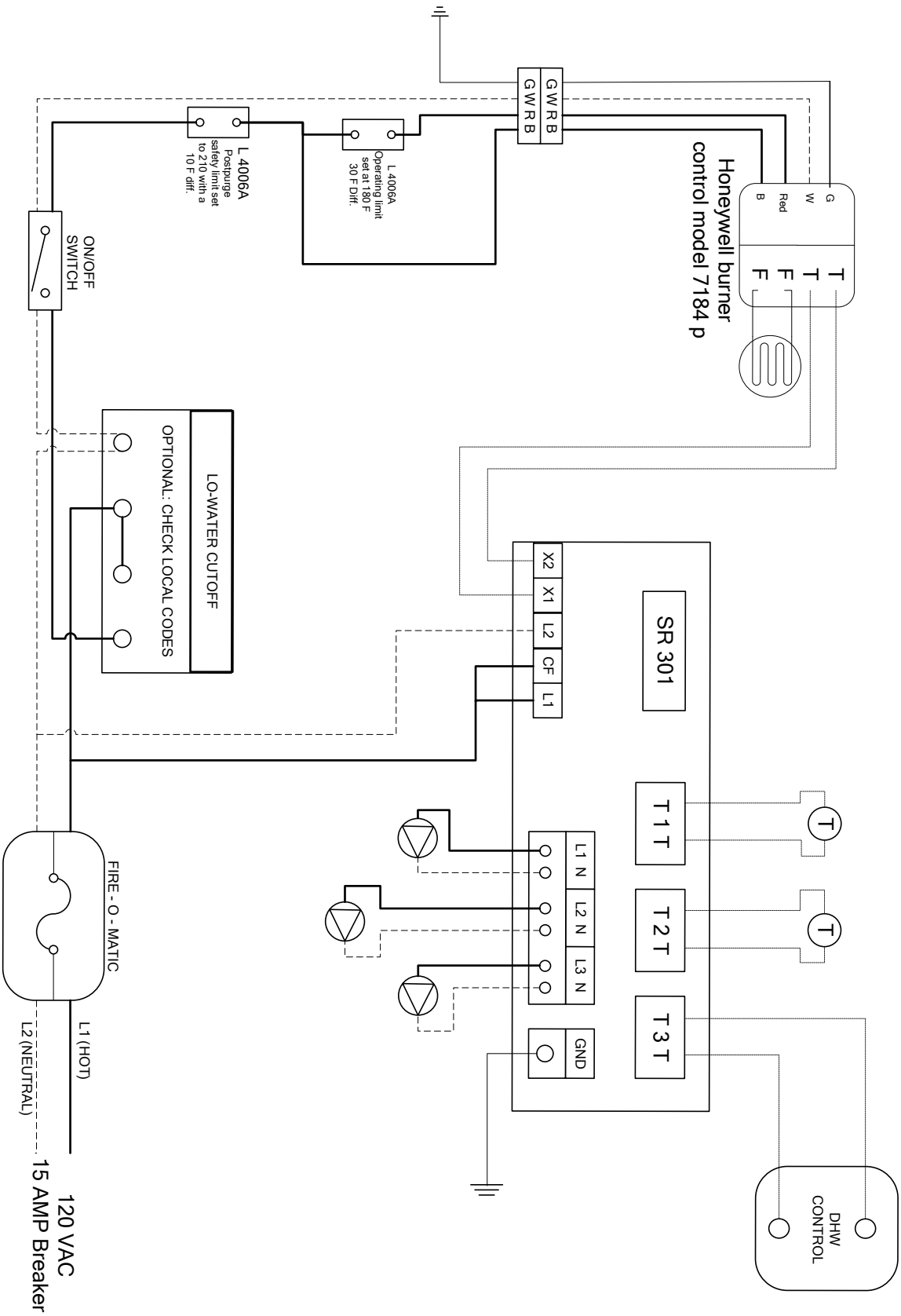

Note 2: All wiring must be done in accordance with applicable state, local and national codes. Use only copper conductors.

5. System Start-up

“For Your Safety Read Before Operating”

WARNING: If you do not follow these instructions exactly, a fire or explosion may result causing property damage, personal injury or loss of life.

WARNING: Improper installation, adjustment, alteration, service or maintenance can cause property damage, personal injury or loss of life. Refer to the user’s information manual provided with this boiler. Installation and service must be performed by a qualified installer, service agency or the gas supplier

WARNING: If installed as a direct vent boiler, make sure after service that both the vent intake and exhaust are both properly reinstalled and sealed.

This appliance does not have a pilot. It is equipped with an ignition device which automatically lights the burner. Do not try to light the burner by hand.

A) **BEFORE OPERATING**, smell all around the appliance area for gas. Be sure to smell next to the floor because some gas is heavier than air and will settle on the floor.

WHAT TO DO IF YOU SMELL GAS

- Do not try to light any appliance
- Do not touch any electric switch; do not use any phone in your building
- Immediately call your gas supplier from a neighbor’s phone. Follow the gas supplier’s instructions.
- If you can not reach your gas supplier call the fire department

B) Do not use this appliance if any part has been under water. Immediately call a qualified service technician to inspect the appliance and to replace any part of the control system and any gas control which has been under water.

OPERATING INSTRUCTIONS:

- 1) **STOP!** Read the safety information above .
- 2) Set thermostat to lowest setting
- 3) Turn off all electric power to the appliance
- 4) Do not attempt to light the burner by hand

5. System Start-up Cont.

- 5) Smell for gas, including near the floor. **If you smell gas, STOP!** Follow “B” in the safety information above on this label. If you don’t smell gas, go to the next step.
- 6) Turn on all electric power to the appliance.
- 7) Set thermostat to the desired setting.
- 8) Once the system is lit, inspect the entire installation.
- 9) Make sure the pressure in the boiler is stable.
- 10) Test both 4006A high limits by lowering their set points below the temperature of the boiler one at a time. If either aquastat fails to shut the burner down replace it immediately.
- 11) Simulate a loss of fuel by shutting the oil valve. Once the valve is closed the burner should go into post – purge and then lockout.
- 12) Reset the burner before turning the oil back on to simulate ignition failure. After ignition failure the burner should go through a purge period and then lockout.
- 13) Open the oil valve and return the burner to operation. While the burner is running, trip the breaker at the panel, that should disable the burner and all other heating controls.
- 14) Once it is determined that the system is operating properly, proceed to tuning up the burner using the proper instruments. If you do not have any instruments, do not place this unit in operation until you have a competent burner technician tune up the burner.

6. Installation Inspection

Recommended procedures for safety inspection of an appliance should be in accordance with the National Fuel Gas Code, ANSI Z223.1. The following procedure will help evaluate the venting system. It is intended as a guide to aid in determining that the venting system is properly installed and is in a safe condition for continuous use. This procedure should be recognized as a generalized procedure which cannot anticipate all situations. Accordingly, in some cases, deviation from this procedure may be necessary to determine safe operation of the equipment. If it is determined that a condition exists which could result in unsafe operation, the appliance should be shut off and the owner advised of the unsafe condition. Corrections must be made before the appliance is put into continuous operation. The following steps should be followed in making a safety inspection.

1. Visually inspect the venting system for proper size and determine that there is no flue gas spillage, blockage, restriction, leakage, corrosion, or other deficiency which could cause an unsafe operation.
2. Place in operation the appliance being inspected. Follow the lighting instructions and adjust thermostat so appliance will operate continuously.
3. Determine that the burner is operating properly and that the burner ignition operates satisfactorily by interrupting and re-establishing the electrical power of the appliance in any convenient manner. Test the burner safety device to determine if it is operating properly by disconnecting the flame safety circuit.
4. Test for smoke spillage at the burner inlet air location around the VRV after 5 minutes of operation. Use a draft gauge, flame of a match or candle, or smoke from a cigarette, cigar or pipe. Shut off appliance thermostat and check for spillage around the VRV. If a flow reversal is noticed, house depressurization is occurring and make up air is required.

Once installation is complete, check the boiler with instruments to ensure that it is working properly.

7. Service & Maintenance

In order to ensure that the boiler is operating properly, it should be inspected annually at the beginning of the heating season by a qualified service technician. Failure to do regular maintenance on the boiler, could result in a loss of system efficiency as well as equipment failure.

- 1) Turn off all electrical power to the boiler before servicing any part of the boiler.
- 2) During the inspection process, the technician should inspect and correct problems that the owner has noted.
- 3) Check the area around the boiler to ensure that no combustibles are in the area.
- 4) Remove any obstruction from the ventilation and combustion air openings to the boiler room. Check to ensure that the openings are open.
- 5) Check the boiler vent discharge and air intake to ensure that they are unobstructed. If obstructions exist, remove.
- 6) Visually check the entire flue gas venting system for blockages, deteriorations and leakages. Repair any problems that are found in accordance with local or national codes. (Failure to repair leakages can result with CO (Carbon Monoxide) Poisoning which can lead to death.)
- 7) Disconnect vent pipe from the breeching and remove front upper and lower door. Use a light to inspect the boiler heating surfaces. If signs of soot are showing, clean boiler heating surfaces with a wire brush and vacuum any debris in the boiler.
- 8) Reconnect the vent pipe to the breeching. Put silicon back onto the joint and tighten the clamps before re-commissioning the boiler.
- 9) With the power to the boiler still off, remove the burner and follow manufactures instructions for cleaning.
- 10) Before putting burner back onto the boiler, check the insulation on the door. If the insulation is damaged or displaced, do not operate the boiler until the insulation has been repaired or replaced. (Failure to replace damaged insulation can result in a fire hazard and can cause personal injury or death, and can cause substantial property damage.)
- 11) Return the boiler to normal operation and check all controls before leaving the job.